



## Options for shallow-water / climate resilient vessels D2.2

Grant Agreement No.	101006364
Start date of Project	01-01-2021
Duration of the Project	30 months
Deliverable Leader	Partner name
Dissemination level	confidential
Status	Final
Submission Date	30-06-2022
Author	Juha Schweighofer via donau – Österreichische Wasserstraßen-G.m.b.H. <a href="mailto:juha.schweighofer@viadonau.org">juha.schweighofer@viadonau.org</a>
Co-author(s)	Jaap Gebraad Sea Europe <a href="mailto:jg@seaeurope.eu">jg@seaeurope.eu</a> Manfred Seitz Danube Commission <a href="mailto:manfred.seitz@danubecommission.org">manfred.seitz@danubecommission.org</a>

This project has received funding from the European Union’s Horizon 2020 research and innovation programme under grant agreement No 101006364. The opinions expressed in this document reflect only the author’s view and in no way reflect the European Commission’s opinions. The European Commission is not responsible for any use that may be made of the information it contains.

## Version

Version #	Date	Author	Organisation
V0.1	25-11-2021	Juha Schweighofer	viadonau
V0.2	04-05-2022	Juha Schweighofer	viadonau
V0.3	27-05-2022	Juha Schweighofer	viadonau
V0.4	30-05-2022	Martin Quispel	SPB/EICB
V0.5	14-06-2022	Juha Schweighofer	viadonau
V0.6	15-06-2022	Martin Quispel	SPB/EICB
V0.7	29-06-2022	Juha Schweighofer	Viadonau
Final	7-12-2002		CINEA

## Release approval

Name	Role	Date
Martin Quispel	WP 2 Leader	30-06-2022
Martin Quispel	Project coordinator	30-06-2022

# Table of contents

Executive summary	5
1. Introduction	16
2. Impacts of shallow water	18
2.1. Navigation conditions	18
2.2. Ship performance	19
2.2.1. Cargo carrying capacity	19
2.2.2. Power demand and fuel consumption	21
2.2.3. Vessel speed and sailing time	26
2.2.4. Manoeuvrability and stopping	26
2.2.5. Safety of navigation	29
2.3. Transportation costs	30
2.4. Modal shift	33
2.5. Economy	33
3. Options for shallow-water vessels	38
3.1. Propulsion systems	38
3.2. Bow thruster	40
3.3. Adjustable tunnel (flex tunnel)	42
3.4. Weight reduction	43
3.4.1. High tensile steel	44
3.4.2. Other material than steel	44
3.4.3. Sandwich Panel Systems (SPS)	44
3.4.4. Adhesive Bonding	46
3.4.5. Optimisation of framing	46
3.4.6. Optimisation by direct calculations	46
3.4.7. Weight reduction potential of some common inland waterway vessels	47
3.5. Shallow-water hulls, new buildings	48
3.5.1. Pusher concept for the Danube	48
3.5.2. Wide-body self-propelled X-type vessel for the Danube	51
3.5.3. NOVIMAR Class Va container ro-ro vessel, shallow draught	53

3.6.	Creation of additional buoyancy	54
3.6.1.	Side blisters	54
3.6.2.	Foldable buoyancy elements	55
3.6.3.	Dock ship	57
3.7.	Stakeholder interviews	57
4.	Recent developments	59
4.1.	FlaBi	59
4.2.	DüPro	59
4.3.	NOVIMOVE - Novel inland waterway transport concepts for moving freight effectively	60
4.4.	Shallow-water tanker of BASF	61
4.5.	HGK-tanker	63
5.	Dedicated subsidy programmes	65
6.	Recommendations for research and development	66
	Annex 1: References	67
	Annex 2: Platina 3 Stage Event 3 (Brussels Sessions) – agenda and minutes of climate change sessions (draft 25.3.2022)	71

# Executive summary

## Introduction

According to NAIADES III, the use of the EU's inland waterway network is currently not optimised due to the lack of coherent infrastructure and fairway quality assurance. Droughts and floods can severely disrupt transport activities by: temporarily blocking waterway sections, imposing restrictions on the amounts of loads transported, and requiring additional vessels to compensate for reduced load factors, or even a shift to other modes of transport. In consequence, under such circumstances, the supply of raw materials and manufactured goods can become insufficient or even interrupted, the transportation costs will increase and the impact on the economy can be dramatic. For example, in the third and fourth quarters of the year 2018, the production losses of the German industry due to persistent low water levels on Rhine river amounted to approximately 4.7 billion EUR. This corresponds to 0.63 % of the entire German industrial production. Several companies had to cope with substantial production losses, like BASF in the order of 250 million EUR and ThyssenKrupp in the order of 100 million EUR.

In general, in the past 200 years, such low water events occurred regularly, although in the last 50 years these events have become less and shorter lasting. However, also in the light of no climate change such events will happen in the coming decades. Accounting for climate change impacts on the hydrology, it is expected that such events will occur more often in the future. For example, in the Rhine area (Lobith) the low water event of 2018 is projected to take place every 10 to 20 years instead of once every 60 years till 2050, according to research findings of Deltares. The impact of the past longer lasting low-water events on inland waterway transport was not that strong as in 2018. The reason is that in those times the vessels were smaller and less vulnerable to water-level changes compared to the much larger new ones which entered operation in the past 20 years. This holds also for a part of the pusher and tug fleet on the Danube which displayed initial design draughts between 1.1 m and 1.5 m in the 1960s and 1970s, while the draughts of most later designed and today's pushers vary between approximately 1.5 m and 2.2 m, allowing for higher propulsive power, larger convoys and, thereby, for greater energy and cost efficiency of the transport at normal water-level conditions.

Considering these severe impacts on the economy and the inland waterway transport as result of low water, which is being increased by climate change impacts, it is necessary to re-evaluate the logistical concepts in place today, including the size and design of inland vessels. New concepts shall contribute to the reduction of the vulnerability of inland waterway transport to low-water events, and they shall be implemented relatively fast, e.g. within a few years, in dedicated single cases e.g. where severe economic losses due to low water shall be avoided.

However, it is stressed that in order to reduce the vulnerability of the entire EU fleet, comprising more than 12 000 operational vessels (PROMINENT (2015)) of which approximately 40 % are assumed to be vulnerable to low water dedicated infrastructure measures, starting with proper maintenance and management of waterways on short term, have to be considered for improving the climate resilience of inland waterway transport on the long term. The argument is also that such a great number of vessels cannot be replaced within a reasonable time frame, considering the associated costs and available ship-yard capacities. In addition, if infrastructure measures are neglected, the navigation conditions will become worse as a consequence. This would result in newly built shallow-water vessels becoming also vulnerable again to climate change effects, reducing thereby the service quality of inland waterway transport.

## Impacts on vessel performance and economy

This report gives a comprehensive overview of the impacts of severe low water on the performance of inland waterway transport and the economy. The impacts can be summarised as described in the following:

- The cargo carrying capacity will be reduced. The reduction is depending on the ship size: larger vessels are more vulnerable to low water than smaller ones if the load factor is considered.
- The power demand and fuel consumption increase due to increased resistance and reduced propulsive efficiency and therefore the emissions increase.
- The vessel speed decreases and the sailing time increases.
- More vessel movements will be necessary for the transportation of the same amount of cargo.

- The manoeuvrability becomes worse, which is depending on the ship type. In certain cases, also positive effects can occur.
- The stopping duration and distance increase due to higher risk of ventilation, reduced thrust and a greater added mass.
- Starting the movement and operation of a vessel may be prevented by ventilation of the propeller, resulting in a reduction of the thrust.
- Common pushers with a draught of approximately 1.8 m are more vulnerable to low water than common motor cargo vessels with a minimum draught of approximately 1.3 m as they have to stop operation at around 2.2 m water depth if for squat and safety allowance 0.4 m are assumed.
- The safety of navigation is reduced due to greater risk of grounding and more vessel movements.
- The transportation costs per tkm and freight rates increase.
- The supply of raw materials and transportation of manufactured products can become insufficient or even interrupted.
- Significant losses in production amounting even to several billion EUR in Western Europe can occur.
- Finally, goods will be shifted to other modes of transport, which will be difficult to revert, as well as which can cause capacity limitations of climate-mitigation relevant infrastructure like railways. A loss transport demand may therefore also occur as result of relocation of production and distribution facilities.

While several measures for coping with low water are already known from past research, e.g. VBD (2004), this report is focussed on recent findings, being clustered in options for shallow water vessels, most recent developments and dedicated subsidy programmes.

### Technical options for shallow-water vessels

*Suitable propulsion systems* of shallow-water vessels aim at preventing possible propeller ventilation, as well as loss of propulsive efficiency at low water while displaying in the best case no increase in energy demand at normal water conditions compared with similar standard vessels. A very effective measure fulfilling this criterion is the application of a flex tunnel with a ducted propeller, which is a further development of the standard propeller tunnel allowing for optimum performance at normal water conditions without a fixed tunnel, which increases the power demand, e.g. a 10 % reduction of fuel consumption is reported by Damen. At small draught the flex tunnel is activated and prevents ventilation. This product is commercially available from Damen Marine Components. Further measures in addition to propeller tunnel and flex tunnel comprise the application of multiple propellers (e.g. three or four instead of two), reducing the propeller load, however, demanding careful investigations with respect to the proper inflow of the water. In cases with very high propeller loads, the application of ducted propellers is very effective as a part of the thrust demanded will be created by the duct.

*A bow thruster* improves the manoeuvring behaviour of a vessel, which usually becomes worse with decreasing water depth. The stopping distance and time, increasing with decreasing water depths, will be reduced due to the additional thrust of the bow thruster acting in opposite direction of the movement of the vessel and braking it. It supports also the vessel movement from standstill as it provides additional thrust reducing thereby the high load of the main propulsion device and the risk of cavitation and ventilation.

The draught of a vessel can be reduced by several *solutions for weight reduction* comprising the application of high tensile steel, other material than steel like aluminium alloys, composites and even wood in combination with steel, Sandwich Panel Systems, adhesive bonding, optimised framing, and weight optimisation by direct strength calculations. The impact of light weight solutions on the draught of a cargo vessel is very limited. According to the ECCONET project, for larger vessels, a draught compensation of around 10 cm was obtained (ECCONET (2012)). However, lightweight solutions can be combined with other measures, e.g. the increase of the width (beam) of the vessel, for minimisation of the draught. Lightweight solutions are expected to increase the construction costs, and one has to make a case-by-case decision if the minor reduction of draught is worth this cost increase.

*Shallow-water hulls and concepts for new buildings* to be operated on the Danube have been developed in the recent years:

A *pusher* with superior shallow-water performance compared with common standard pushers with a draught of approximately 1.8 m was developed featuring the following characteristics:  $L_{OA} = 30$  m,  $B_{OA} = 11.00$  m,  $H = 2.5$  m,  $T = 1.4$  m, three diesel powered drive trains with 700 kW each, three ducted propellers in tunnels, bow thruster 250 up to 300 kW. Taking into account the benefits of the application of the latest technological achievements increasing efficiency, safety, environmental performance and comfort, a new pusher design will be most probably superior to a conventional elder design created according to the standards 30 or more years ago. This report contains a set of *guidelines for the design of a Danube shallow water pusher* taken from Radojčić et al. (2021).

Starting with the Innovative Danube Vessel project (IDV (2014)), several developments with respect to *shallow-water motor cargo vessels* were carried out, finally resulting in a wide-body self-propelled X-type vessel for the Danube, displaying a design draught of 2.3 m and a respectable deadweight of 2248 t. The low draught was achieved by increasing the width and reducing the height of the vessel, combined with direct strength calculations and goal-based design of its structure resulting in a light weight not exceeding the one of a standard design, although partially strengthening of the structure had to be foreseen. The propulsion system is diesel powered with twin ducted propellers (propeller diameter = 1.55 m).

In the Horizon 2020 EU project NOVIMAR, two *shallow draught versions of the NOVIMAR Class Va container ro-ro vessel* have been designed with the purpose to enable navigation in shallow waters such as parts of the river Danube and the Rhine: one “stern access version” concept and one “double end access version” concept. The shallow draught design comes unavoidably with a number of draw-backs. With no cargo below the main deck, the space utilisation and cargo space capacity are reduced as well as the stability due to a higher centre of gravity. However, the concepts have the potential to provide attractive waterborne services, where available water depth is a significant limitation. The main dimensions are:  $L_{OA} = 104$  m,  $B_{OA} = 11.45$  m,  $H = 3.0$  m,  $T = 2.0$  m, TEU = 104 (a’ 11.3 t, deadweight = 1317 t, first version) and 100 (a’ 11.8 t, deadweight = 1298 t, second version), up to three tiers of containers are possible,  $P_B = 2 \times 550$  kW (2 x 750 hp).

Also for operation in the Rhine area, several tanker concepts have been developed which are already now in operation or which will enter operation in 2022 and in the coming years, see below: “*most recent vessels concepts under construction and in operation*”.

*The creation of additional buoyancy* was initially investigated in the FP7 EU project ECCONET. The basic idea is based on devices creating additional buoyancy when needed for coping with low water. Under favourable conditions, close to those for which the ship is actually optimised, the devices would be put away and the ship would continue the service with optimal performance. Based on the first results, further development is being carried out in the Horizon 2020 project NOVIMOVE, including more detailed performance calculations and comprehensive design activities. Solutions for the creation of additional buoyancy are moveable side blisters made of steel of different shapes or inflatable devices like membrane air pads. Further solutions comprise foldable buoyancy elements integrated into the ship’s body which can be laterally extracted. At present, practical experiences of side blisters in use, be it cylindrical or laterally foldable solutions are not known yet. Finally, the usage of a dock ship taking a vessel onboard at a reduced final draught of the transportation system has been considered in NOVIMOVE. The conceptual design of a dock ship is oriented towards a selected bottleneck, e.g. a distinct shallow water area. To pass short sections of the fairway with insufficient water depth, two different attempts are conceivable to help loaded vessels; on the one hand a powered dock ship and on the other hand a similar module without own propulsion system.

## Stakeholder interviews

A comprehensive set of stakeholder interviews is available in Scholten and Rothstein (2012). 417 persons representing shipowners were asked for an interview, 55 complete questionnaires were returned. According to the shipowners interviewed the following adaptation measures relating to ship technology can be thought of as feasible: modified aft-ship form, additional usage of (smaller) vessels, construction and provision of smaller vessels, 24-hours operation of vessels, usage of light-weight materials, better adaptation of the amount of cargo to be loaded to available fairway depths, as well as improved manoeuvrability. Arguments against the measures listed are mainly the associated costs and minimum draught of vessels being not reduced, as well as shortage of staff if vessels are to be operated 24 hours per day. Here some potential for improvement was observed: only about one third of vessels involved in the interviews were operated 24 hours a day, although 75 % of the vessels had two or more persons with a boat-master certificate on board, allowing for 24-hours operation. Finally, the importance of financing smaller vessels by banks was highlighted.

## Most recent research

*FlaBi*: The overall objective of the joint project “FlaBi” is to increase the resilience of inland vessels during pronounced periods of drought by extending their operational limits. To achieve this goal, innovative ship designs with suitable propulsion systems in combination with lightweight structures are developed for the requirements of the Rhine and Elbe river at extreme low water levels. In addition, a retrofit concept for propulsion and steering devices are developed for the existing fleet, which will improve suitability for extreme low-water conditions. In the sub-project “FlaBiTec”, DST is investigating three different propulsion concepts, a 2<sup>nd</sup> generation blade-chain drive, a modified paddle wheel drive and the conventional ducted propeller with regard to their operational limits. The appropriate integration of the propulsors into the ship’s hull represents a major challenge. In addition to different propulsors, design measures to reduce the lightweight are also being investigated. The technical developments will be suitably combined in dedicated ship designs. Subsequent model tests serve to identify the operational limits of the designed ships and enable a comparison with existing ships.

Duration: December 2020 – November 2023.

<https://www.dst-org.de/verbundvorhaben-flabi-gestartet/>

*DüPro*, based on the outcomes of the project “*Determination of the effective propeller inflow for inland navigation*” of DST focussed on systematic investigations of the complex interactions between ship, propulsor and waterway. For this purpose, numerous propulsion and open water tests with different arrangements were carried out. Building upon the results of the propeller inflow project, two of the hull forms tested there were built on a larger scale, so that additional information on scale effects could be obtained. In addition, one aft ship each with rudder propellers and the modern flex-tunnel concept was designed, built on a model scale and tested. The investigations were supplemented by CFD simulations and PIV measurements.

Duration: November 2018 – May 2022

<https://www.dst-org.de/en/duepro-systematic-investigation-of-ducted-propellers-for-inland-navigation/>

*NOVIMOVE - Novel inland waterway transport concepts for moving freight effectively* is a Horizon 2020 EU project which focusses amongst others on smart river navigation by merging satellite (Galileo) and real time river water depths data; smooth passage through bridges/locks by a dynamic scheduling system for better corridor management along the TEN-T Rhine-Alpine (RALP) route; and concepts for innovative vessels that can adapt to low water condition while maintaining a full payload. Some of the measures mentioned above with respect to additional buoyancy were already preliminarily considered in previous projects like the FP7-ECCONET (steel side blisters, inflatable blisters and foldable buoyancy elements as theoretical concepts). Building upon the preliminary results, in NOVIMOVE further developments are carried out aiming at raising the Technology Readiness Level (TRL) of these concepts. The corresponding work includes iterative detailing of hydrodynamic characteristics, regulatory and operational aspects, determination of related investment costs (CAPEX) and operating cost (OPEX) as well as structural design. For the latest developments, the reader is advised to visit the website below.

Duration: June 2020 – May 2024

[www.novimove.eu](http://www.novimove.eu)



## **Practical implementations: most recent vessels concepts under construction and in operation**

*The BASF shallow-water tanker* is a highly innovative vessel currently under construction to enter operation end of 2022. Following the experience with the low water levels of the Rhine in 2018 when a suitable ship and sufficient alternative transport capacity was not available, BASF decided to acquire a dedicated tanker in order to secure its production at Ludwigshafen. The vessel features the following characteristics improving its performance at low and normal water conditions: increased main dimensions: L = 135 m, B = 17.5 m instead of L = 110 m, B = 11.4 m; improved cargo carrying capacity at low water: 650 t at T = 1.2 m, and 2500 t at T = 2.05 m; diesel-electric propulsion system with stage V engines for very low emissions; three electric drivetrains with three propellers optimised for shallow water operation and normal water conditions; the outer propellers have a smaller diameter than the centre propeller which ensures additional thrust at normal water conditions; three rudder blades behind the outer propellers for sufficient rudder force, one rudder blade at the centre propeller; one integrated Van der Velden® FLEX Tunnel left and right of the outer drive trains; hydrodynamic optimisation using model tests; lightweight construction ensuring high structural stability by transferring methods from seagoing shipbuilding to inland waterway vessels.

*The HGK gas tanker "Gas 94"* entered operation in September 2021 as answer to the low-water event of 2018. A contract for the construction of second tanker to be delivered in 2023 has been signed in 2022, and five additional vessels are to follow in the coming years. The improved shallow-water performance has been achieved by proper design and engineering and not by usage of alternative materials. The vessel displays the following features: L = 110 m, B = 12.5 m (slightly increased breadth instead of 11.45 m), depth = 5.6 m; voluminous foreship; diffusor-like aft ship preventing ventilation at low water depths; small propeller diameters; reduced draught by 30 to 40 cm; Power Management System and diesel-electric propulsion: three ducted rudder propellers, each driven by a 405 kWe electric motor: 30 % less CO<sub>2</sub> emissions; optimisation of design of cargo tanks for weight reduction; higher construction costs in comparison with standard vessels.

## **Dedicated subsidy programmes**

In Germany the importance of coping with climate change impacts on inland waterway transport has been acknowledged in the national funding programme for the sustainable modernisation of inland vessels (Richtlinie zur Förderung der nachhaltigen Modernisierung von Binnenschiffen vom 24. Juni 2021). It supports amongst others dedicated measures for optimisation of cargo vessels for improved operation at low water. This can comprise for example: exchange of the aft ship by another one; optimisation of the aft ship by different constructive implementations, optimisation of the foreship by constructive modifications for reduction of resistance; installation of assistance solutions for improved manoeuvring, e.g. bow thrusters.

Following the same reasoning, In Austria, a subsidy programme containing similar items as the one of Germany has been initiated by the Federal Ministry for Climate Action, being currently under evaluation.

## **Needs for further development**

In general, it is necessary to re-evaluate the logistical concepts in place today, including the size and design of vessels. According to the CCNR, the consideration of smaller vessels being able to be operated together with a lighter will gain more significance. In addition, research and development activities targeting existing vessels, as well as new buildings will be required. Such new concepts will contribute to the reduction of the vulnerability of inland waterway transport to low-water events, but they will not solve the problem what for additional measures with respect to climate resilient infrastructure, provision of reliable information with respect to navigation conditions, as well as logistics and vessel operation are required. While measures for adaptation of existing vessels are relatively limited (exchange of the aft ship could be viable solution), aiming largely at increasing the cargo capacity at low water, new buildings show a greater potential for implementation of a number of measures, e.g. lightweight solutions, multiple propulsion devices, hull-form optimisation, variation of main parameters, etc., resulting in improved shallow-water performance and competitive performance at normal water levels.

More research is needed with respect to the provision of reliable data on and forecasting of environmental framework conditions as a precondition for the proper retrofitting and design of inland waterway vessels. The adaptation measures shall not negatively affect the operation of vessels at normal navigation conditions, e.g. increasing the energy demand.

Better understanding of the real sailing profiles allows the vessels to be designed more in line with the real conditions, which is also required for the energy transition. The ship design has to be optimised for the real operating conditions, taking into account rising OPEX with sustainable energy carriers, new ship main dimensions, structures, drivetrains, hull forms and the associated hydrodynamics. Showing still a lot of room for improvement, manoeuvring models for automatic navigation shall be developed, leading possibly to a business case for smaller units, e.g. due to lower personnel costs as a part of the ship operation may be carried out automatically with less personnel. In general, measures relating to the improvement of the competitiveness of smaller, less vulnerable vessels in comparison to bigger ones shall be elaborated, including the creation of regulations for proper implementation. Investigations of extreme shallow water conditions request further research with respect to interaction with river beds and squat effects in combination with small under-keel clearance.

Reliable and efficient prediction of ship operation with ventilating propellers is to be further investigated. In general, model tests and numerical methods can be used for this purpose. Challenges of model tests relate to the assessment of scaling effects, correct propeller loading and application of proper friction deduction force. Numerical simulations are associated with high computational costs for large-Reynolds-number simulations and propeller modelling. Further challenges relate to turbulence modelling and free-surface capturing. The objectives to be achieved are save accelerations, save stopping and save manoeuvres.

Finally, the impact of the introduction of new low-emission or zero-emission solutions for coping with the climate objectives of the EU, increasing eventually the weight and size of vessels, e.g., by full-electric sailing or usage of hydrogen and fuel cells, has to be considered with respect to proper operation during low-water events.

With respect to the adaptation of the fleet, a dialogue between industry, logistics, politics, and environmental organisations, as well as regulations and funding for modernisation on European level will be necessary. Proper cooperation between the different stakeholders and an integrated approach for coping with climate change is necessary, what for also the European institutions are needed.

## List of figures

Figure 1: Schematic sketch of fairway and fairway channel of an inland waterway (Petronell-Witzelsdorf, Austrian Danube). Source: viadonau. ....	18
Figure 2: Schematic sketch of fairway parameters of an inland waterway. Reproduced from viadonau (2019). ....	18
Figure 3: Deadweight of common inland waterway vessels and pushed convoys in Europe. The deadweight distribution over the draught starts at the minimum draught of the vessel demanded for safe navigation. It ends at the maximum draught the vessel is designed for. Illustration created based on Klein and Meißner (2019) and internal data of viadonau. ....	20
Figure 4: Delivered power PD versus speed V of the motor cargo vessel Herso 1 (L = 84.95 m, B = 9.5 m, T <sub>max</sub> = 2.7 m, tdw <sub>max</sub> = 1382 t) in single operation presented for water depths H ranging from 3 m up to deep water. Vessel draught = 2 m. Source: Schweighofer and Suvačarov (2018). ....	22
Figure 5: Wave pattern at sub-critical (a), critical (b) and super-critical (c) speeds. Source: Radojčić et al. (2021). ....	23
Figure 6: Impact of Froude number based on water depth on the bow-wave angle. Source: Radojčić et al. (2021). ....	23
Figure 7: Wave-making resistance R <sub>w</sub> vs. Fn <sub>h</sub> in deep (dashed line) and shallow water (water depths h <sub>1</sub> >h <sub>2</sub> >h <sub>3</sub> ). Source: Radojčić et al. (2021). ....	24
Figure 8: Transitional speed V with respect to waterway depth h. Source: Radojčić et al. (2021). ....	24
Figure 9: Fuel consumption of main engines and auxiliary engines of a pushed convoy comprising a motor cargo vessel and a lighter, presented for one round trip, downstream operation and upstream operation. Stretch sailed: Budapest – Regensburg. Period 1 = January with low water, period 6 = June with relatively high water. Reproduced from Godjevac et al. (2014). ....	25
Figure 10: Loss in ship speed in % due to shallow water according to Lackenby. AM, ΩM = midship section area, H, h = water depth, V, V <sub>0</sub> = ship speed in deep water, g = gravity constant, Fh = Froude number based on the water depth (V/(g h) <sup>1/2</sup> ). ΔV = loss in ship speed. Sources: left figure: Bertram (2012), right figure: Pompée (2015). ....	26
Figure 11: Turning circles and 20/20 zigzag tests with a ship model (confidential) at 10%, 20%, and 100% UKC (= (h-T)/T), performed at BSHC, Varna, Bulgaria, on behalf of FHR, Antwerp, Belgium. Source: Vantorre et al. (2017). ....	27
Figure 12: Comparisons of ship trajectories in shallow water and deep water. Source: Liu et al. (2015). ....	28
Figure 13: Turning trajectories of a pusher-barge system at rudder angles 20° (left) and 35° (right) Source: Liu et al. (2015). ....	28
Figure 14: Distribution of accidents due to human, technical, environmental and other reasons in percent related to inland waterway transport on the Danube River in Austria for the years 2000 up to 2006. Reproduced from Schweighofer (2013). ....	29
Figure 15: Development of grounding events on the Upper and Middle Rhine within 2002 and 2010. Source: Schweighofer (2013). ....	30
Figure 16: Development of water depths at Bingen/Ostrich and specific transportation costs of a large motor cargo vessel (GMS, bulk cargo) presented for the years 2002 (moderate and high water levels) and 2003 (low water). Reproduced from Holtmann and Bialonski (2009). ....	31
Figure 17: Development of cargo transported, number of shipments and freight rate of inland waterway transport on the Rhine in the year 2018. Reproduced from ZKR – Zentralkommission für die Rheinschifffahrt (2021), source: BASF. ....	31
Figure 18: Development of freight rate index for gasoil from the ARA region to destinations on the Rhine (index 2015 = 100). Source: CCNR (2019 a) (calculation of CCNR based on PJK International, gasoil freight rates including pilotage, harbour and canal dues). ....	32
Figure 19: Development of freight-rate indexes for dry cargo, metals, and container transport in the Rhine basin (the Netherlands, Belgium, traditional Rhine) between 2015 and 2018 (index 2015 = 100). Reproduced from CCNR (2019 a). ....	32
Figure 20: Development of transport performance in million tkm on European inland waterways between 2015 and 2019. Source: CCNR (2019 b). ....	35
Figure 21: Goods transported on the traditional Rhine by type of goods in million tonnes, presented for the years 2013 up to 2018. Impact of low water during the year 2018 on the amount of transported goods. Source: CCNR (2019 a). ....	35
Figure 22: Impact of low water period on the Rhine in 2018 on the German industrial production. Source: CCNR (2019 a). ....	36
Figure 23: Impact of low water on the Rhine in 2018 on the German industrial production. Losses in billion EUR in the months August up to December, estimated by the CCNR. Reproduced from ZKR (2021). ....	36
Figure 24: Number of days per year with a discharge Q < 783 m <sup>3</sup> /s (= equivalent low water discharge) at Kaub, Middle Rhine, including 30-year moving averages. Source: CCNR (2019 a). ....	37
Figure 25: Ideal efficiency and open water efficiencies of different propulsors presented as function of the thrust loading coefficient C <sub>Th</sub> . Source: Breslin and Anderson (1994). ....	38
Figure 26: Comparison of propulsion concepts and draught-requirements in relation to the propeller diameter. A minimum of draught of e.g. 150 % means a draught equal to 1.5 x propeller diameter. Source: Ramne et al. (2020). ....	39

Figure 27: Different propulsion solutions for operation in shallow water. Top, left: propeller in tunnel; top, right: propeller in tunnel with deep apron; bottom: propeller with flex tunnel, active. Source: Guesnet et al. (2021), DST.....	39
Figure 28: Sketch of open water propeller characteristics. The thrust coefficient $K_T$ is highest at the bollard pull condition which corresponds to a ship speed $V = 0$ km/h. Source: Molland et al. (2017). .....	40
Figure 29: Schottel Pump-Jet and Veth’s Compact-Jet. Source: Radojčić et al. (2021).....	41
Figure 30: Bottom view of a model of a 4-channel thruster. Source: Peeters et al. (2020), Radojčić et al. (2021). .....	41
Figure 31: Adjustable tunnel aprons (in functional model scale) - to be retracted into the hull if the ship utilises its full draught in deep water (above) - to be extracted when the ship operates with small draught in low water (below). Source: DST, ECCONET (2012). .....	42
Figure 32: Flex Tunnel of Van der Velden. Left: retracted into the hull if the ship. Right: extracted for operation with small draught at low water depths. Source: Damen .....	43
Figure 33: SPS vs. conventional structure. Source: Radojčić et al. (2021), SPS Technology (2020). .....	45
Figure 34: Steel weight comparisons between an existing Danube barge (lighter 77 m x 11 m x 2.8 m) and calculated solutions according to Lloyds Register (LR) comprising mixed and longitudinal framing, as well as SPS. Source: Radojčić et al. (2021). ..	45
Figure 35: FEM analyses of one unconventional IW vessel: Von Mises stresses in $N/mm^2$ . Source: Radojčić et al. (2021), Stefanović (2019). .....	47
Figure 36: Shallow-water pusher for the Danube. Source: Radojčić et al. (2021). .....	49
Figure 37: Wide-body self-propelled X-type vessel for the Danube. Source: Radojčić et al. (2021), Bačkalov et al. (2016). .....	51
Figure 38: Wide-body self-propelled X-type vessel for the Danube: gross scantlings of the mid body cross section. Source: Radojčić et al. (2021), Bačkalov et al. (2016).....	52
Figure 39: NOVIMAR Class Va container ro-ro vessel, shallow draft designs: “stern access” concept (left), “double-end access” concept right). Source: NOVIMAR 2(020). .....	53
Figure 40: Inland vessel without and with side blisters. Source: ECCONET (2012). .....	54
Figure 41: Modular coupling concept used to connect temporary air pads (left). Membrane air pad concept: schematic view with vessel (right). Source: Ramne et al. (2020). .....	55
Figure 42: General arrangement of an inland waterway vessel with foldable buoyancy elements. Source: ECCONET (2012)...	56
Figure 43: Cross section of an inland waterway vessel with foldable buoyancy elements. Source: ECCONET (2012). .....	56
Figure 44: Design sketch of a simple dock ship structure which can be used modularly (left). Model of the concept design of a dock ship including propulsion and steering units with pronounced propeller tunnels developed in the H2020 EU project Novimove. Source: Ramne et al. (2020).....	57
Figure 45: Shallow-water tanker of BASF. Source: BASF. ....	62
Figure 46: Van der Velden® Three-rudder system (left) and Van der Velden® FLEX Tunnel of the BASF tanker. Source: Damen. ....	62
Figure 47: Animation of shallow-water gas tanker “Gas 94” of HGK Shipping. Source: HGK Shipping.....	63

## List of tables

Table 1: Members of the PLATINA 3 Advisory Board involved in Task 2.2 (Options for shallow water / climate resilient vessels). .....	17
Table 2: Main characteristics of different common ship types in Europe (minimum, maximum draught and minimum, maximum deadweight). Table created based on Klein and Meißner (201907) and internal data of viadonau. ....	21
Table 3: Impact of low water on the Rhine in 2018 on the production of different organisations. Reproduced from Streng et al. (2020). ....	36
Table 4: Possible weight savings on typical Rhine vessels. Source: ECCONET (2012). ....	47
Table 5: Possible weight savings on typical Danube vessels. Source: ECCONET (2012). ....	48
Table 6: Main characteristics of shallow-water pusher for the Danube compared with the ones of four common pushers on the Danube (Radojčić et al. (2021)). ....	48
Table 7: Main characteristics of different vessels concepts and vessels in operation on the Danube. Source: IDV (2014), Radojčić (2009), Bačkalov et al. (2016), Prominent (2015). ....	52
Table 8: Payload gained through the application of side blisters to different common inland waterway vessels. Source: ECCONET (2012). ....	54
Table 9: Payload gained through the application of foldable buoyancy elements to different common inland waterway vessels. Source: ECCONET (2012). ....	56
Table 10: Draught reduction in relation to length. Source: Ramne et al. (2020). ....	57

## List of abbreviations

$A_M$	midship section area
ARA	Amsterdam, Rotterdam, Antwerp
B	breadth
BfG	Bundesanstalt für Gewässerkunde, Federal Institute of Hydrology of Germany
$B_{OA}$	breadth over all
CAPEX	capital expenditures
CEMT	European Conference of Ministers of Transport
CEO	Chief Executive Officer
CFD	computational fluid dynamics
cm	centimetre
CCNR	Central Commission for the Navigation of the Rhine
$CO_2$	carbon dioxide
$C_{Th}$	thrust loading coefficient
Deltares	Knowledge institute for applied research in the field of water and subsurface of the Netherlands
d	draught
D	diameter
dm	decimetre
DNV-GL	Det Norske Veritas – German Lloyd
DST	Development Centre for Ship Technology and Transport Systems
ES-TRIN	European Standard laying down Technical Requirements for Inland Navigation vessels
FEM	finite element method
$Fn_h$	Froude number based on water depth
g	gravity constant, gramme
GIW	“gleichwertiger Wasserstand”, equivalent water level
GLQ	discharge corresponding to GIW
GMS	large motor cargo vessel
h	hour, water depth
H	height, water depth
hp	horse power
HTS	high tensile steel
IDV	Innovative Danube Vessel
IPCC	Intergovernmental Panel on Climate Change
IWT	inland waterway transport, inland waterborne transport
J	advance coefficient
kg	kilogramme
km	kilometre
kN	kilonewton
$K_Q$	torque coefficient
kt	kilotonne

---

$K_T$	thrust coefficient
kW	kilowatt
kWe	kilowatt-electric
L	length
LNWL	low navigable water level
LNQ	discharge corresponding to LNWL
$L_{OA}$	length over all
LR	Lloyds Register
m	meter
$m_{DWT}$	deadweight
MGS	motor cargo vessel
$m_{LWT}$	lightweight
OLR	“agreed low water level - Overeengekomen Lage Rivierstand”
OPEX	operational expenditures
P	propeller pitch
$P_B$	brake power
P/D	pitch ratio
$P_D$	delivered power
PIV	particle image velocimetry
Q	discharge
$R_w$	wave-making resistance
s	second
SPS	Sandwich Panel Systems
t	tonne, thrust deduction
T	draught, thrust
TEU	twenty-foot equivalent unit
tkm	tonne kilometre
TRL	technology readiness level
UKC	under-keel clearance
v	velocity
$V_A$	speed of advance of propeller
VBD	Versuchsanstalt für Binnenschiffbau e.V.
w	wake fraction
ZKR	CCNR
$\delta$	rudder angle
$\delta V$	loss in ship speed
$\eta$	efficiency
$\eta_D$	propulsive efficiency
$\eta_I$	efficiency of an ideal propeller
$\rho$	density
$\Omega_M$	midship section area

## 1. Introduction

The Horizon 2020 PLATINA 3<sup>1</sup> project provides a platform for the implementation of the European Commission's NAIADES III action programme (European Commission (2021)), dedicated to inland navigation. PLATINA 3 is structured around four fields:

- market (WP1);
- fleet (WP2);
- jobs and skills (WP3); and
- infrastructure (WP4).

The work package 2 "Fleet" deals with various aspects of the fleet, such as

- a zero-emission fleet;
- a climate resilient fleet;
- digital and automated vessels;
- technical regulations and standards for the fleet and fuels; and
- accurate fleet data.

This report addresses the topic 'climate resilient fleet', which is Task 2.2 of PLATINA 3 according to the Grant Agreement. The title of Task 2.2 is "Options for shallow-water / climate resilient vessels", and viadonau leads the execution of this task. The objective according to the Grant Agreement is: *"Improve IWT competitiveness by ship-technology measures for coping with climate change effects"*, which is in line with the actions to be taken requested by NAIADES III: *"Moreover, the greater frequency of low-water events will require a faster development and roll-out of innovative, climate-adaptable vessels able to sail with low water levels while minimising impacts on aquatic ecosystems"*.

As regards the contents of this report to guide the reader:

- Chapter 2 provides a comprehensive overview of the impacts of low water on navigation conditions, the performance of inland waterway vessels comprising numerous vessel types sailing in different areas (Rhine, Danube, Elbe, North-West-European canals), transportation costs, modal shift and the economy, clarifying the complexity of the topic and highlighting the necessity for adaptation.
- Chapter 3 summarises a greater number of different technical options for coping with low water, covering propulsion systems, thruster solutions, tunnels, weight reduction, shallow-water hulls and newbuildings, as well as solutions for provision of additional buoyancy.
- Chapter 4 is dedicated to most recent developments dealing with shallow-water vessels, comprising descriptions of most recent research projects, as well as vessels delivered and under construction.
- Chapter 5 highlights the importance of the topic by referring to the German subsidy programme for the sustainable modernisation of inland waterway vessels (Richtlinie zur Förderung der nachhaltigen Modernisierung von Binnenschiffen), which supports measures for improved shallow-water performance of such vessels.
- Chapter 6 gives recommendations for further development and research.
- A concise state of the art on the topic and stakeholder input of the inland waterway transport sector became available through the PLATINA 3 Stage Event 3 (Brussels Sessions), see Annex 2.

While several measures for coping with low water are already known from past research, e.g. VBD (2004), INBAT (2005), this report is focussed on recent findings.

In addition to the consideration of a comprehensive set of stakeholder interviews of Scholten and Rothstein (2012), stakeholder involvement and reception of feedback was realised through the organisation and conduction of the PLATINA 3 Stage Event 3 (Brussels Sessions, 236 registrants, 22 representing shipowners, 13 representing

<sup>1</sup> <https://platina3.eu>



equipment providers, 10 representing logistics companies), as well as the involvement of the majority of the PLATINA 3 Advisory Board from the beginning on of the creation of this deliverable.

The Advisory Board involved comprises the following organisations:

Table 1: Members of the PLATINA 3 Advisory Board involved in Task 2.2 (Options for shallow water / climate resilient vessels).

International Sava River Basin Commission	Željko Milković Dusko Isakovic
CBR	Adri van der Hoeven
European Barge Union (EBU)	Theresia Hacksteiner
German Federal Ministry for Digital and Transport (BMDV)	Muhammed Elemenler Peter Segieth
Ministry of Transport and Construction Slovakia (MoTCS)	Juraj Staroň
Ministry of Transport Romania (MoTR)	Cristina Cuc
Ministry of Infrastructure and Water management The Netherlands (Ministerie I&W)	Gert Mensink
Flanders Ministry of Mobility and Public Works (MOW)	Sim Turf Maxim Van den Bossche
University Antwerp	Edwin van Hassel
Development Centre for Ship Technology and Transport Systems (DST)	Benjamin Friedhoff
European Education in Inland Navigation (EDINNA)	Arjen Mintjes
Deltares	Rolien van der Mark

The feedback received and recommendations for improvement are gratefully acknowledged.

## 2. Impacts of shallow water

### 2.1. Navigation conditions

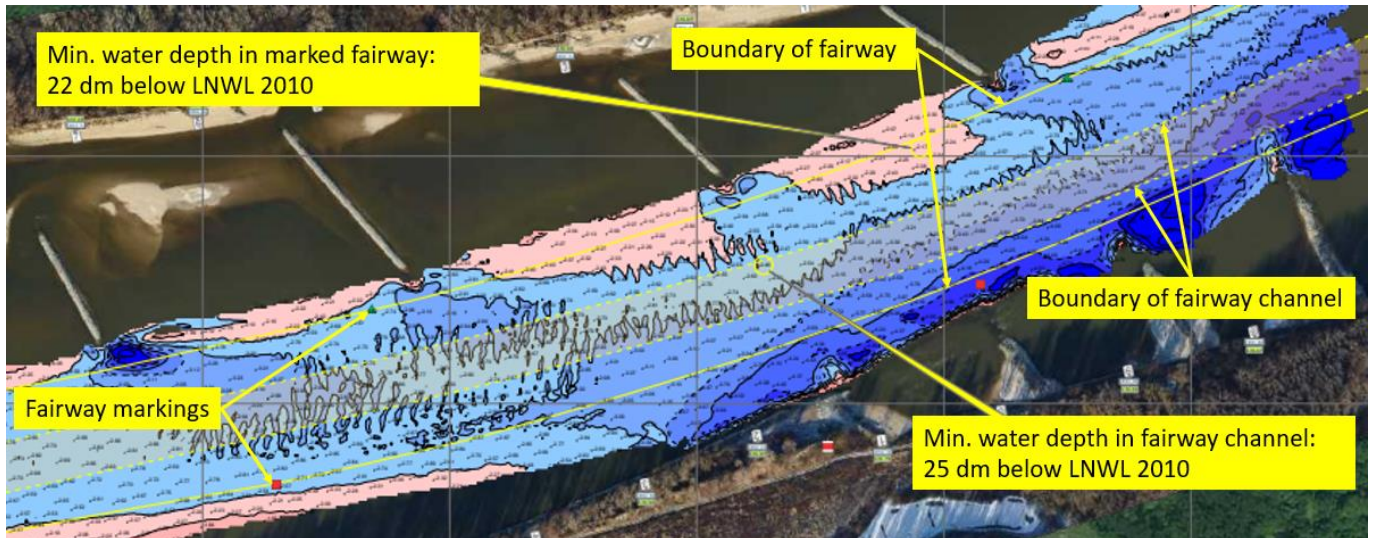

Figure 1: Schematic sketch of fairway and fairway channel of an inland waterway (Petronell-Witzelsdorf, Austrian Danube). Source: viadonau.

The term fairway refers to the part of an inland waterway that is navigable for shipping at a particular water level and that is marked by fairway signs (Fig. 1). The fairway channel is the area of a body of inland water for which the waterway administration seeks adherence to certain fairway depths and fairway widths for navigation purposes. The fairway channel is therefore part of the fairway. A “minimal” cross section is assumed on rivers in determining the cross-section of the channel, so its depth and width. It is derived from the “shallowest” and “narrowest” points of a certain river section at low water. The authorities and organisations responsible for maintaining a waterway aim to keep fairways at a constant minimum depth, e.g. by conservational dredging measures in the fairway. These so-called minimum fairway channel depths are geared to e.g. the low navigable water level (LNWL) as a statistical reference value for the water level on the Danube. On the Rhine, the so-called “Gleichwertiger Wasserstand” (GIW) and in the Netherlands the so-called “agreed low water level - Overeengekomen Lage Rivierstand” (OLR) are used.

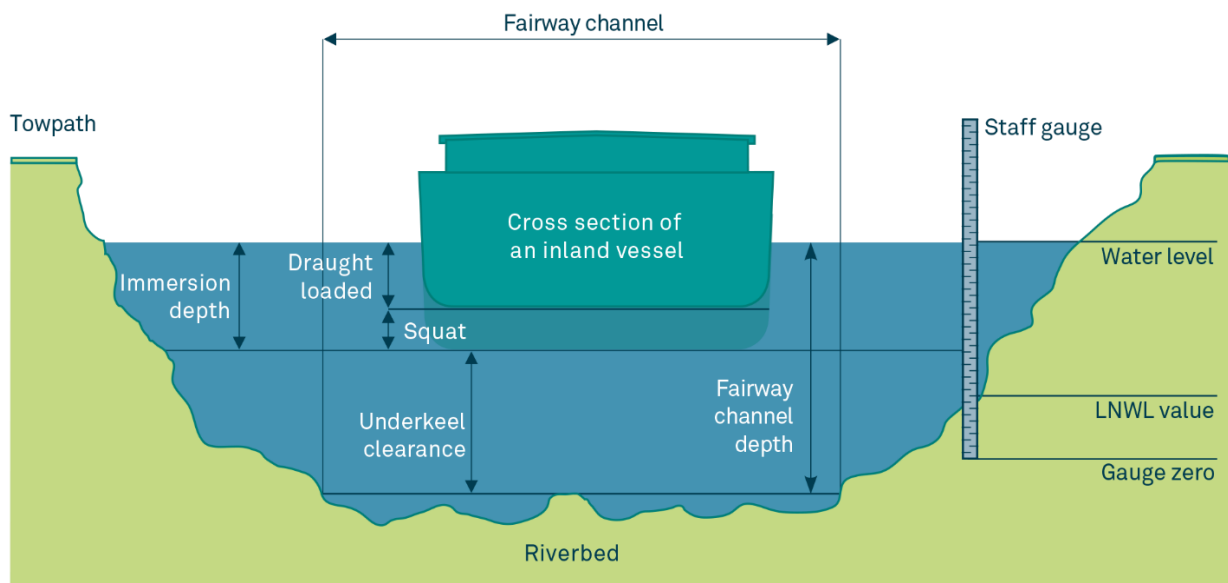

Figure 2: Schematic sketch of fairway parameters of an inland waterway. Reproduced from viadonau (2019).

Fairway depths available in the fairway channel determine how many tons of goods may be carried on an inland cargo vessel. The more cargo loaded on board of a vessel, the higher is its draught loaded, i.e. the draught of a ship when stationary and when carrying a certain load. The draughts loaded usable for navigation companies have a decisive influence on the cost-effectiveness of inland waterway transport.

In calculating the potential draught loaded of a vessel on the basis of current fairway or fairway channel depths, the dynamic squat as well as an appropriate safety clearance to the riverbed, the so-called underkeel clearance, have to be considered in order to prevent groundings of vessels in motion (Fig. 2). The immersion depth of a ship equals the sum of its draught loaded (loaded vessel in static condition; velocity  $v = 0$ ) and its squat (loaded vessel in motion; velocity  $v > 0$ ).

The squat refers to the level to which a ship sinks while it is in motion compared to its stationary condition on waterways with a limited cross section (i.e. rivers and canals). A loaded vessel has a squat within a range of about 20 to 40 centimetres. As the squat of a vessel is continually changing according to the different cross sections of a river and the different velocities of a vessel, the boatmaster has to consider in addition a safety clearance between the riverbed and the bottom of the vessel when determining the draught his vessel is to be loaded. This safety clearance is termed underkeel clearance and is defined as the distance between the bottom of a vessel in motion and the highest point of the riverbed. The underkeel clearance should not be less than 20 centimetres for a riverbed made of gravel or 30 centimetres for a rocky bed in order to prevent damage to the ship's propeller and/or its bottom. For sandy riverbeds, the changes in morphology can be much greater, demanding under circumstances even greater safety allowances.

Low water levels caused e.g. by drought may reduce the depth available for navigation to values which result in a restriction of the vessel's operational draught and its loading capacity. In addition, the fairway widths for safe navigation may be reduced, too. Apart from the geometrical limitations caused by low water, the flow velocities will decrease. These effects will be strongest for free-flowing sections of a river, where significant fluctuations of water depth and flow velocities may occur. Compounded sections display usually sufficient water depths for navigation at almost all circumstances. However, the flow velocities can be affected noticeably by drought resulting in very low values. On canals, the water depths and the flow velocities show a rather stable behaviour in general. In severe drought periods, problems can arise also on canals as they are fed by river water and extractions may take place for other economic and societal functions.

## 2.2. Ship performance

### 2.2.1. Cargo carrying capacity

On European waterways, the water levels accept regularly such low values that many vessels cannot be loaded up to their maximum draught, resulting in reduction of the available deadweight (sum of provisions and cargo carried) and cargo carrying capacity. In severe cases, e.g. low water corresponding to the ones present in the years 2003 and 2018, the draught has to be reduced significantly, leading to uneconomic operation of the vessel, and if the minimum draught has to be exceeded, then the vessel will be prevented from safe operation or it cannot be even operated at all, e.g. due to ventilation.

The impact of the draught on the deadweight is presented for different vessel types sailing European waterways in Fig. 3. The deadweight distribution over the draught is approximately linear as the vessels considered have a very long parallel body of the hull. Seagoing vessels have usually in relation to their lengths shorter parallel bodies, resulting in a non-linear distribution. The deadweight distribution starts at the minimum draught of the vessel and it ends at the maximum draught the vessel is designed for. The vessel can be loaded to draughts less than the minimum draught. However, then a safe operation of the vessel will not be possible anymore. This area is not displayed in the figure. A reduction of draught will cause a reduction of the deadweight available for transportation of cargo, being different for each vessel. Larger vessels and pushed convoys designed for transportation of great

amounts of cargo show significant reductions. E.g. for the pushed convoy on the Rhine or the Danube (4 lighters), a reduction of deadweight by approximately 330 t per 10 cm is obtained. For the large cargo vessel (110 m), 145 t and for the small Gustav Koenigs vessel, 57 t are obtained. The negative impact on revenue is greatest for larger vessels as it is depending on the cargo carried. The economic operation of a vessel is depending on its load factor being the relation between the cargo carried and the maximum amount of loading which can be taken on board. Considering as example a ship draught of 2 m, resulting in an approximate demand of 2.4 m up to 2.5 m for the water depth, the load factors of the following vessels are: pushed convoy (Rhine) = 40 %, the large motor cargo vessel (GMS 135) = 45 %, the large motor cargo vessel (GMS 110) = 40 %, the small Gustav Koenigs = 64 %, the shallow-water pushed convoy (Elbe) = 95 % and the pushed convoy (Danube) = 68 %<sup>2</sup>. The larger vessels show a greater sensitivity to low water events. Uneconomic load factors are reached already at moderately low water levels. Less sensitive to low water levels are smaller vessels, e.g. a Gustav Koenigs vessel, and pushed convoys using pushers with very low draughts, e.g. the pushed convoy operating on the Elbe. At the draught considered, the pushed convoy operating on the Danube shows also a reasonable load factor. However, if the water level is further reduced, only a maximum vessel draught of less than 1.8 m might be permitted, resulting in suspension of operation of the pushed convoy, which holds also for the one operating on the Rhine. For completeness, it is noted that on the Danube, pushers with a draught of less than 1.8 m are in operation, e.g. draughts down to approximately 1.3 m can be observed. However, values between 1.6 m and 2 m are common. In Table 2, the main characteristics of different common ship types in Europe are given. The table contains information with respect to the minimum and the maximum draught, as well as the corresponding values for the deadweight.

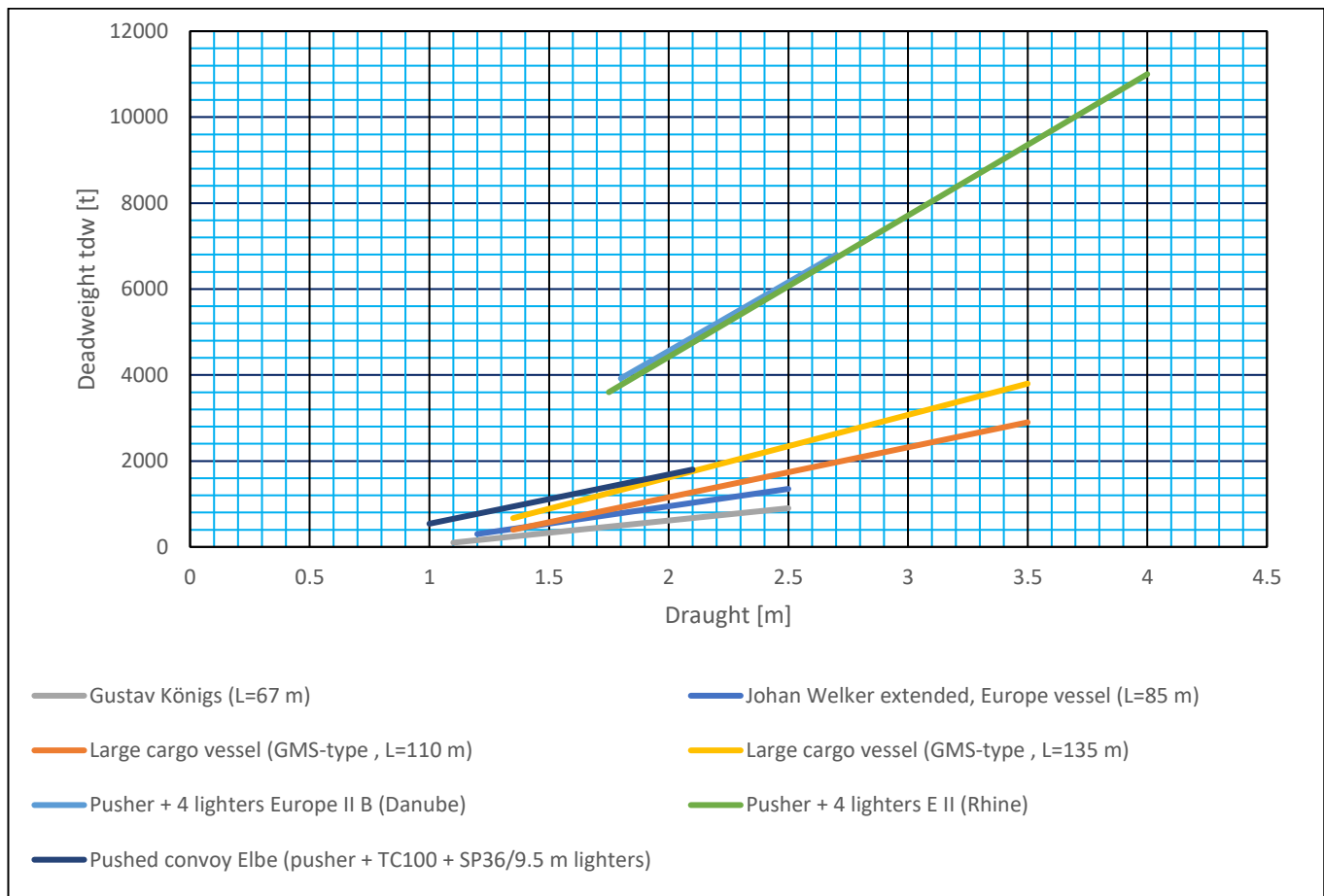

Figure 3: Deadweight of common inland waterway vessels and pushed convoys in Europe. The deadweight distribution over the draught starts at the minimum draught of the vessel demanded for safe navigation. It ends at the maximum draught the vessel is designed for. Illustration created based on Klein and Meißner (2019) and internal data of viadonau.

<sup>2</sup> The provisions, e.g. fuel carried, have been deduced from the deadweight at the considered draught. The maximum deadweight is considered as the maximum load of the vessel used in the calculation of the load factor.

Table 2: Main characteristics of different common ship types in Europe (minimum, maximum draught and minimum, maximum deadweight). Table created based on Klein and Meißner (201907) and internal data of viadonau.

Vessel type	Length L [m]	Width B [m]	Draught $T_{max}$ [m]	Draught $T_{min}$ [m] <sup>3</sup>	Deadweight $tdw_{max}$ [t]	Deadweight $tdw_{min}$ [t]
Gustav Koenigs	67	8.2	2.5	1.1	900	100
Gustav Koenigs ext.	80	8.2	2.5	1.1	1100	250
Johann Welker	80	9.5	2.5	1.2	1250	380
Johann Welker ext. (Europe vessel)	85	9.5	2.5	1.2	1350	300
Stein type cargo vessel (GMS 95 m)	95	11.4	2.7	1.3	2000	530
Large cargo vessel (GMS 110 m)	110	11.45	3.5	1.35	2900	400
Large cargo vessel (GMS 135 m)	135	11.45	3.5	1.35	3800	670
JOWI (container vessel)	135	16.8	3.5	1.6	5200	1300
Coupled convoy Rhine consisting of GMS-110 + 1 E II-lighter)	186.5	11.45	3.5	1.35	5200	1000
Pushed convoy Rhine (pusher + 2 x 2 E II-lighters)	153	19	4	1,75	11000	3600
Coupled convoy Danube (GMS-95 + E II B-lighters)	171.5	11.4	2.7	1.3	3700	1105
Pushed convoy Danube (pusher + 2 x 2 E II B-lighters)	188	22	2.7	1.8	6800	3920
Pushed convoy Danube (pusher + 2 E II B-lighters)	188	11	2.7	1.8	3400	1960
Pushed convoy Elbe (pusher +TC100+SP36/9.5 m lighters)	129	9.5	2.1	1	1800	540

### 2.2.2. Power demand and fuel consumption

In comparison to a seagoing vessel sailing open waters without limitation of water depth and width with exceptions in coastal areas and in the port, an inland waterway vessel is usually operated in waters with limited water depth and fairway width. Due to the limitation of the water depth, the cross sections in the vicinity of the vessel in general as well as the one between the keel and the river bottom in particular are reduced. As a result of the continuity and the Bernoulli equations, the flow velocities below and aside the vessel increase and the pressure minima become more distinct. In addition, the pattern of the flow changes from a three-dimensional one to a more two-dimensional one, meaning that a greater amount of water is shifted from the bottom to the sides, which can be problematic for vessels with three propellers as the one in the centre of the propeller arrangement may suffer from a lack of incoming water. Even in the case of sufficient availability of water in the propeller plane, negative impacts may occur as the direction and speed of the incoming flow have changed, impacting the propulsive efficiency  $\eta_D$ .

In general, the power demand for operation of a vessel at a given speed is increasing, the shallower the water is. Alternatively, when the operation of the vessel is performed with constant engine power then the speed is reduced the shallower the water is. In both cases, the fuel consumption is increased at same rate as the power or the velocity are increased. These effects become more distinct when the width is limited too, e.g. in a canal. However, in a

<sup>3</sup> The minimum draught  $T_{min}$  is the draught of the empty vessel trimmed aft and measured between the lowest point of the vessel and the undisturbed water line, as well as the draught of the vessel sailing with even keel which allows still for safe operation of the vessel. Therefore, the vessel carries some provisions or cargo at  $T_{min}$ . If the minimum draught is exceeded, safe operation is not guaranteed anymore.

canal, rather low power values associated with a low fuel consumption may be observed. This is due to the speed limitations in some canals which result in very low ship speeds, e.g. 11 km/h in the Main-Danube canal.

In Fig. 4, the delivered power  $P_D$  versus the speed  $V$  of the motor cargo vessel Herso 1 in single operation is presented for water depths  $H$  ranging from 3 m up to deep water. The vessel draught for these speed/power profiles was  $T = 2$  m. Considering the ship speed in calm water of 10 km/h, the requested power for achieving this speed amounts to approximately 100 kW in deep water and 135 kW at a water depth of 3 m. For a ship speed in calm water of 15 km/h, the requested delivered power amounts to 225 kW in deep water and 900 kW in water with a water depth of 3 m.

The significant impact on the power requirement at higher speeds and low water depth is clearly demonstrated for the speed of 15 km/h. Here, the power demand has increased by 300 % (=  $(900-225)/225 \cdot 100$ )! Similarly, the impact of shallow water on the ship speed can be derived from Fig. 4. Assuming a delivered power of 500 kW, the ship speed in deep water amounts to 18 km/h, and, at 3 m water depth, it amounts to 14 km/h, resulting in an increase of sailing time in calm water with a limited water depth. For this vessel, the impact of shallow water on the power demand is visible even for relatively great water depths, e.g. equal to 8 m.

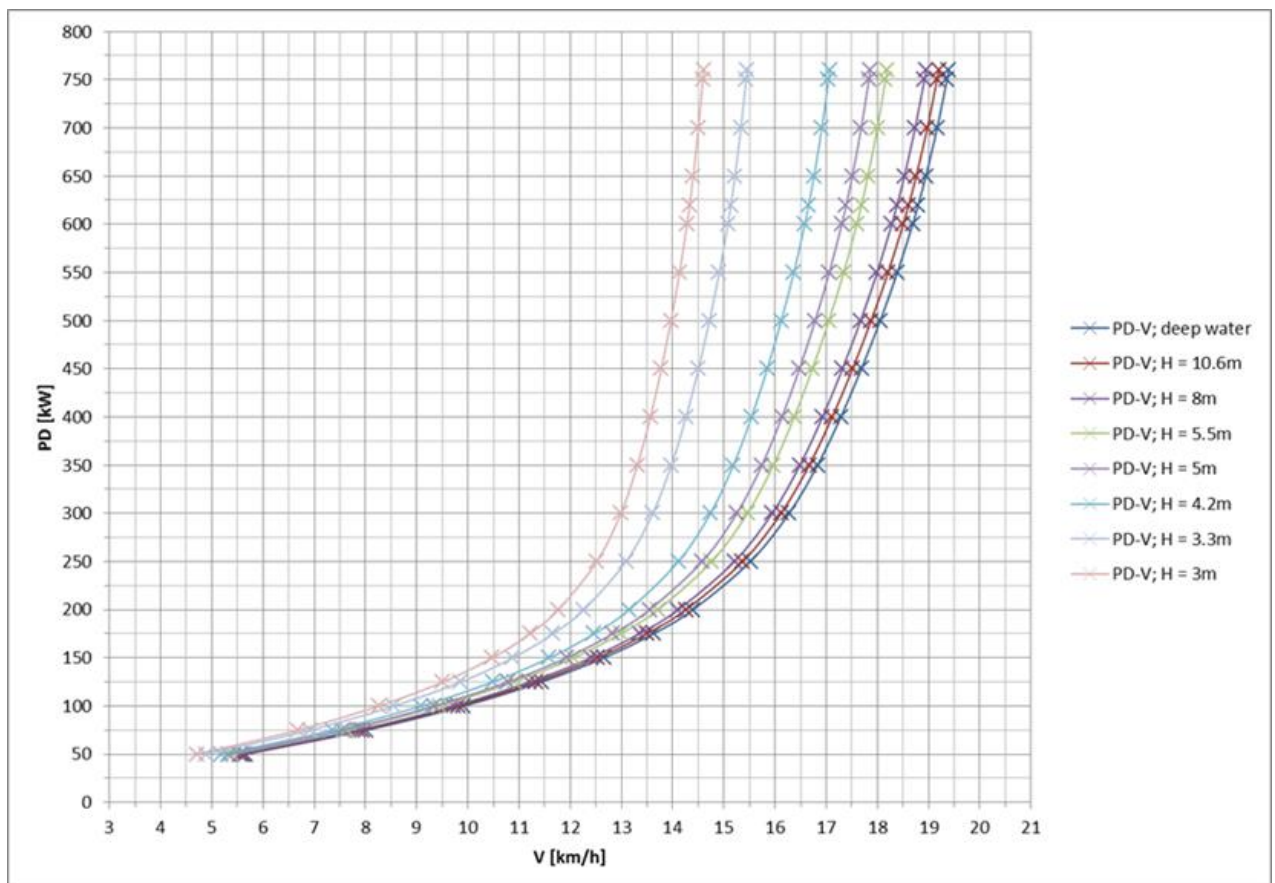

Figure 4: Delivered power  $P_D$  versus speed  $V$  of the motor cargo vessel Herso 1 ( $L = 84.95$  m,  $B = 9.5$  m,  $T_{\max} = 2.7$  m,  $tdw_{\max} = 1382$  t) in single operation presented for water depths  $H$  ranging from 3 m up to deep water. Vessel draught = 2 m. Source: Schweighofer and Suvačarov (2018).

The increased power demand in shallow water results from an increase of the ship resistance as well as a decrease of the propulsive efficiency. According to Radojčić et al. (2021), shallow water has an effect on the ship resistance if:

- $h/T < 4$ , or
- $F_{n_h} > 0.5$ , where  $F_{n_h} = V/\sqrt{g \cdot h}$  is the Froude number based on the water depth  $h$ ,  $V$  is the speed of the vessel,  $g$  is the gravity constant and  $T$  is the draught of the vessel.

Most inland waterway vessels fulfil at least one, if not both criteria, indicating that in these cases special attention should be paid to shallow-water effects on the ship resistance.

The wave-making resistance can be affected significantly by shallow water, caused by the change of the flow field around the vessel, resulting in increased wave amplitudes (Radojčić et al. (2021)) and wave lengths (Schneekluth (1988)) and a change of the wave pattern, comprising changes of the diverging and transversal waves (Figs. 5 and 6).

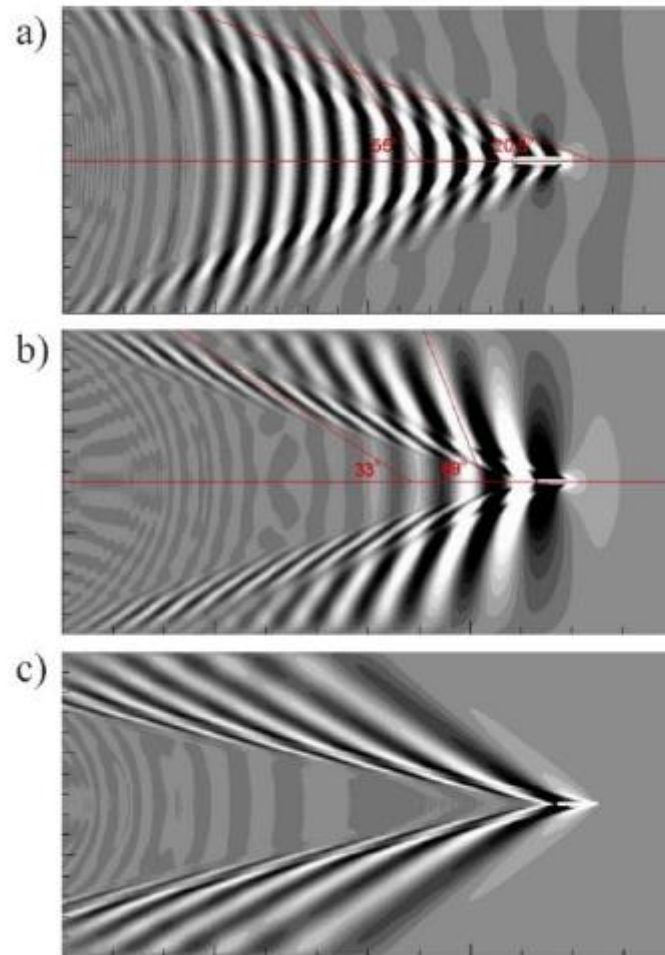

Figure 5: Wave pattern at sub-critical (a), critical (b) and super-critical (c) speeds. Source: Radojčić et al. (2021).

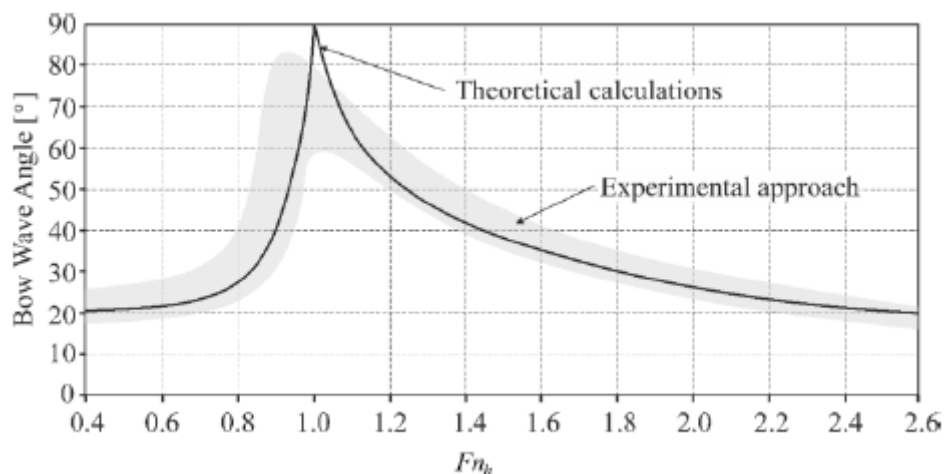

Figure 6: Impact of Froude number based on water depth on the bow-wave angle. Source: Radojčić et al. (2021).

Starting at approximately  $Fn_h = 0.4$  the bow-wave angle (Kelvin angle) starts to increase with increasing  $Fn_h$ . In theory, at the critical  $Fn_h = 1$ , the Kelvin angle becomes  $90^\circ$ , resulting in a significant increase of the bow wave and wave heights as well as the wave making resistance. In practice, the critical  $Fn_h$  is little smaller. When  $Fn_h$  exceeds 1, the Kelvin angle becomes smaller and the transversal waves vanish. The remaining wave system comprises only diverging waves and the wave resistance becomes even lower than the one in deep water at approximately  $Fn_h > 1.25$ .

A sketch of the development of the wave-making resistance in deep and shallow water with respect to the depth Froude number and the ship speed is shown in Figs. 7 and 8, respectively. In Fig. 8, three characteristic areas are distinguished:

- sub-critical ( $Fn_h < \text{approx. } 0.65$ ) where the effects of the water depth are small,
- critical (approx.  $0.65 < Fn_h < \text{approx. } 1.25$  with maximum at  $Fn_h \approx 0.96$ ) where the effects of water depth can be extremely pronounced and negative, and
- super-critical ( $Fn_h > \text{approx. } 1.25$ ) where the effects are relatively small but generally favourable, i.e. the wave resistance in shallow water  $R_{Wh} < \text{the wave resistance in deep water } R_{W\infty}$ .

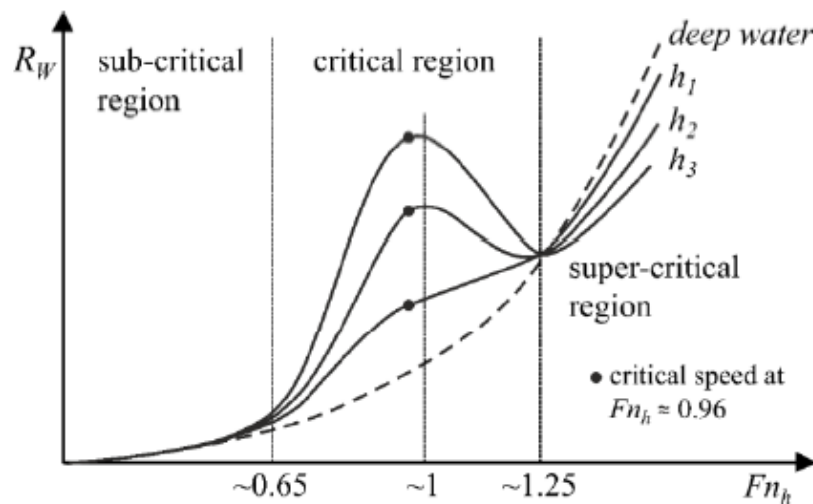

Figure 7: Wave-making resistance  $R_w$  vs.  $Fn_h$  in deep (dashed line) and shallow water (water depths  $h_1 > h_2 > h_3$ ). Source: Radojčić et al. (2021).

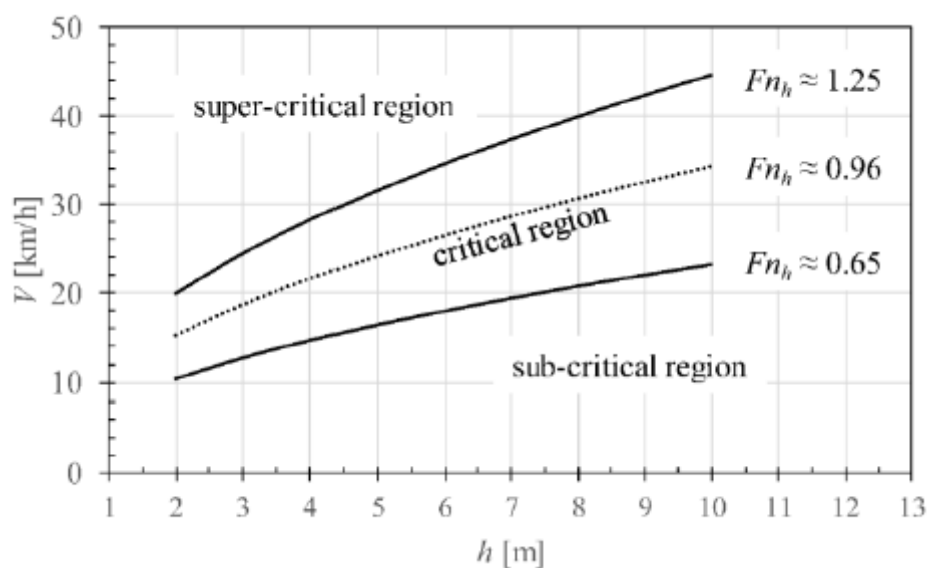

Figure 8: Transitional speed  $V$  with respect to waterway depth  $h$ . Source: Radojčić et al. (2021).



Due to the increased velocities around the hull of a vessel, the shear stresses acting on the hull increase, resulting in an increase of its frictional resistance, being a part of the viscous resistance. In general, shallow water causes an increase of the viscous resistance of a vessel.

The power demand of a vessel is not only determined by its resistance. The propulsive efficiency is also one determining factor, being influenced by the following phenomena:

- non-axisymmetric (i.e. oblique) water inflow caused by the propeller tunnels;
- non-uniform water inflow to the propeller, caused by the nozzle integrated into the hull (to facilitate installation of the larger propeller), and struts and flanking rudders if present;
- overloading of a propeller as the ship resistance increases in shallow water;
- potential cavitation (as the inflow to the propeller is insufficient, which leads to a decrease of pressure in the surrounding water).

According to Radojčić et al. (2021), the propulsive efficiency of inland waterway vessels in shallow water is usually between 40 % and 50 %. However, it can become as low as 20 % up to 30 % (Pompée (2015)). The majority of the Danube pushers have relatively low propulsive efficiencies of around 30 % up to 40 % (Bilen and Zerjal (1999)), though these can also be lower, depending on several factors.

In reality, the impact of low water on the fuel consumption of a vessel can be also relatively moderate, which can be caused by the flow velocities of the river and the loading of the vessel (e.g. loaded only upstream or downstream). In Fig. 9, the total fuel consumption of vessel sailing between Budapest and Regensburg is presented for a round trip, operation downstream and operation upstream. The results are given for 12 periods which correspond very well to the months January up to December. Details can be found in Godjevac et al. (2014). The period 1 corresponds to operation at low water and a vessel draught of 1.7 m and the period 6 corresponds to operation at relatively high water and a vessel draught of 2.0 m. The vessel was loaded only in upstream direction. The figure shows that low water increases only very little the total fuel consumption of the vessel. In the upstream direction, it is even reduced as the flow velocities and the draught of the vessel are reduced, resulting in a higher velocity over ground and lower energy demand for the upstream voyage. However, when sailing downstream, the resistance and power demand are increased as the speed through water had to be increased for a given service speed and the shallow water resistance acts on the vessel. Considering, the transport performance, the impact of low water becomes also in this case significant showing how important the amount of cargo transported is for the relative fuel consumption. In the example below, the relative fuel consumption per round trip is increased from 8.7 g/tkm to 11.4 g/tkm by low water (comparison periods 1 and 6).

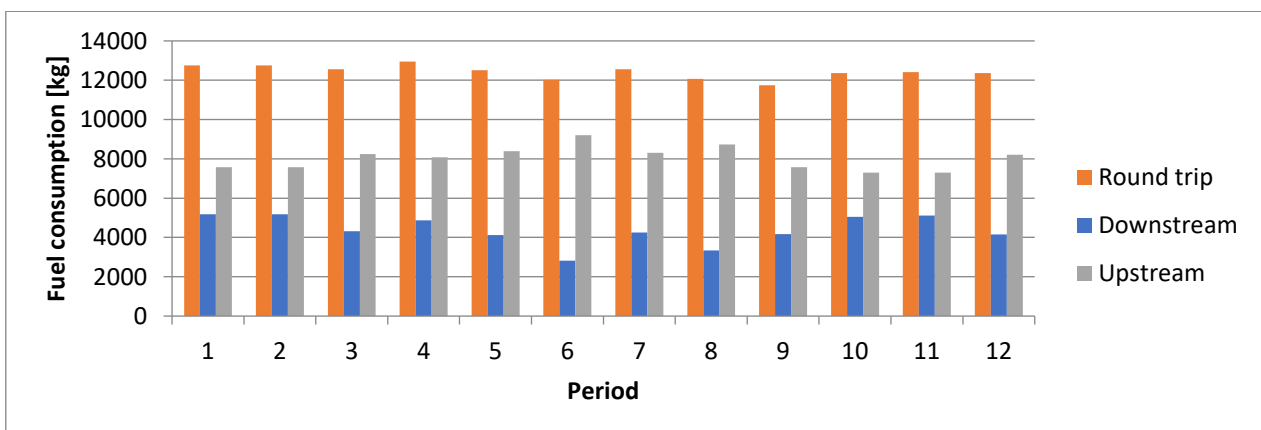

Figure 9: Fuel consumption of main engines and auxiliary engines of a pushed convoy comprising a motor cargo vessel and a lighter, presented for one round trip, downstream operation and upstream operation. Stretch sailed: Budapest – Regensburg. Period 1 = January with low water, period 6 = June with relatively high water. Reproduced from Godjevac et al. (2014).

### 2.2.3. Vessel speed and sailing time

Shallow water increases the resistance and power demand of a vessel. For a given engine power, this circumstance results in a loss of vessel speed which increases with decreasing water depth (see Fig. 4). The loss in vessel speed leads to an increase of sailing time being directly related to the vessel speed. For a first evaluation of the loss in vessel speed, the method of Lackenby can be used. For quick application, the formula is represented as graphs in the Fig. 10. (Bertram (2012), Pompée (2015)). Knowing the mid ship area  $A_M$ ,  $\Omega_M$ , the water depth  $H$ ,  $h$  and the ship speed in deep water  $V$ ,  $V_0$ , the loss in ship speed in % of the speed in deep water can be derived from the graphs in Fig. 10 or application of the formula of Lackenby. The method of Lackenby can be used in cases with weak shallow-water effects (Bertram, 2012). In the case of strong shallow-water effects, the physical phenomena become that complex that simple corrections like the one of Lackenby may be not sufficient anymore and testing or application of numerical methods have to be applied (Bertram, 2012). In the literature, a great number of different methods for estimation of the shallow-water impact on vessel speed and resistance can be found, see Pompée (2015), Radojčić et al. (2021), Rottevel (2013).

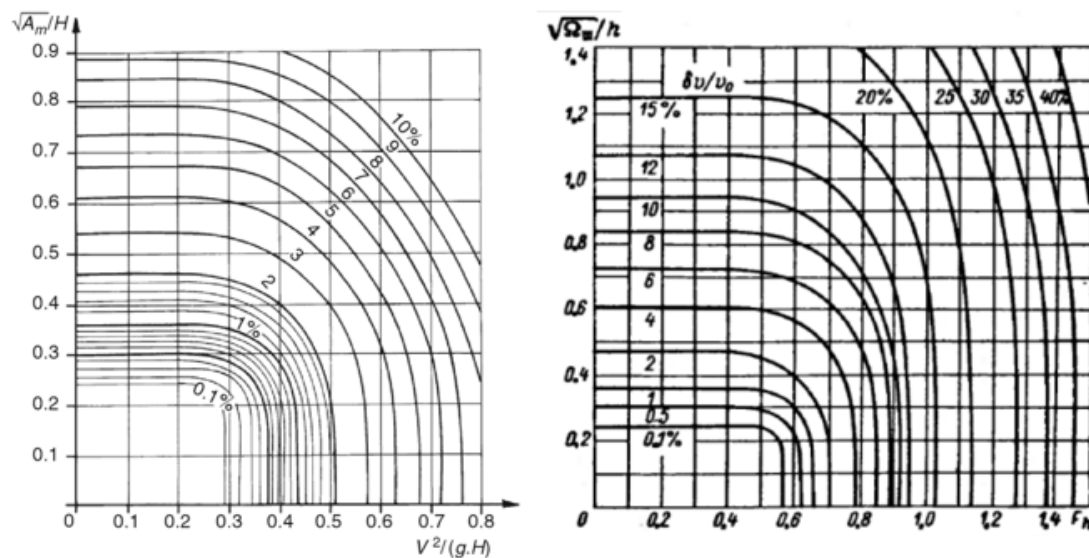

Figure 10: Loss in ship speed in % due to shallow water according to Lackenby.  $A_M$ ,  $\Omega_M$  = midship section area,  $H$ ,  $h$  = water depth,  $V$ ,  $V_0$  = ship speed in deep water,  $g$  = gravity constant,  $F_h$  = Froude number based on the water depth  $(V/(g h)^{1/2})$ .  $\delta V$  = loss in ship speed. Sources: left figure: Bertram (2012), right figure: Pompée (2015).

The increase in sailing time can be very substantial, depending on the respective, transportation case, e.g. for some vessels of the shipping company NAVROM, the low water on the Danube in 2015 resulted in transportation times two up to three times higher than under normal water level conditions (22 days instead of 7 days, Negrea (2016)). Larger convoys comprising nine lighters had to be separated in smaller convoys consisting of one or two lighters, resulting in more ship movements relating to the transportation of the same amount of cargo, increasing also thereby the time for the delivery of cargo.

### 2.2.4. Manoeuvrability and stopping

Shallow water has an effect on the manoeuvrability of a vessel, as the flow field around the vessel is impacted by the limited water depth. According to Vantorre et al. (2017), the hydrodynamic forces acting on the vessel as well as its inertia including the added masses and inertia moments of sway increase. The impact of shallow water on the rudder forces seems to remain negligible. However, in the case of rudder action, an asymmetric pressure field around the rudder will be induced extending to the aft part of the hull. The sum of the rudder induced forces acting on the rudders and the hull increases in magnitude and the centre of action moves farther forward in relation to the ship. The effect on the yawing moment may become less important, and when the rudder induced total force (rudder + hull) acts in the forepart of the vessel, an adverse effect on the control actions may be encountered.

The impact of shallow water on the manoeuvrability of a vessel is not easy to be answered due to the complexity of the topic. In most cases, it has a negative impact and the manoeuvrability becomes worse than in deep water, which is shown in Fig. 11, displaying the turning circles and 20/20 zigzag tests of a ship model at 10 %, 20 %, and 100 % under-keel clearance UKC ( $= (h-T)/T$ ).  $h$  is the water depth and  $T$  is the draught of the vessel. Here, a reduction of the under-keel clearance increases the diameter of the turning circle and reduces the amplitude of the oscillating zigzag path.

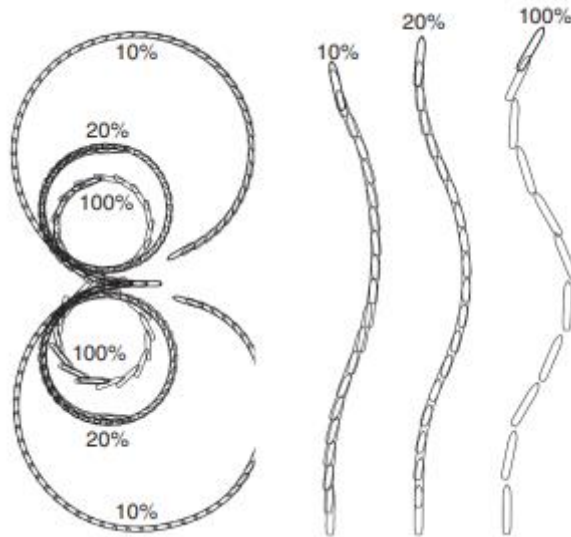

Figure 11: Turning circles and 20/20 zigzag tests with a ship model (confidential) at 10%, 20%, and 100% UKC ( $= (h-T)/T$ ), performed at BSHC, Varna, Bulgaria, on behalf of FHR, Antwerp, Belgium. Source: Vantorre et al. (2017).

The impact of shallow water on the manoeuvrability of a vessel is also depending on the vessel type, which is shown in Fig. 12, displaying the turning circles for 4 different vessels and three ratios of water depth and vessel draught. For the ships A, B and D a negative impact of shallow water is obtained. However, for ship C, the impact becomes positive, meaning that shallow-water effects need not to be always negative. This vessel was a twin-screw vessel with a wide beam, somehow similar to an inland waterway vessel. The reason for this exceptional behaviour was an increase of the rudder forces due to high propeller loading in shallow water. A similar result is obtained for a pushed convoy comprising a pusher and lighters (barges), see Fig. 13.

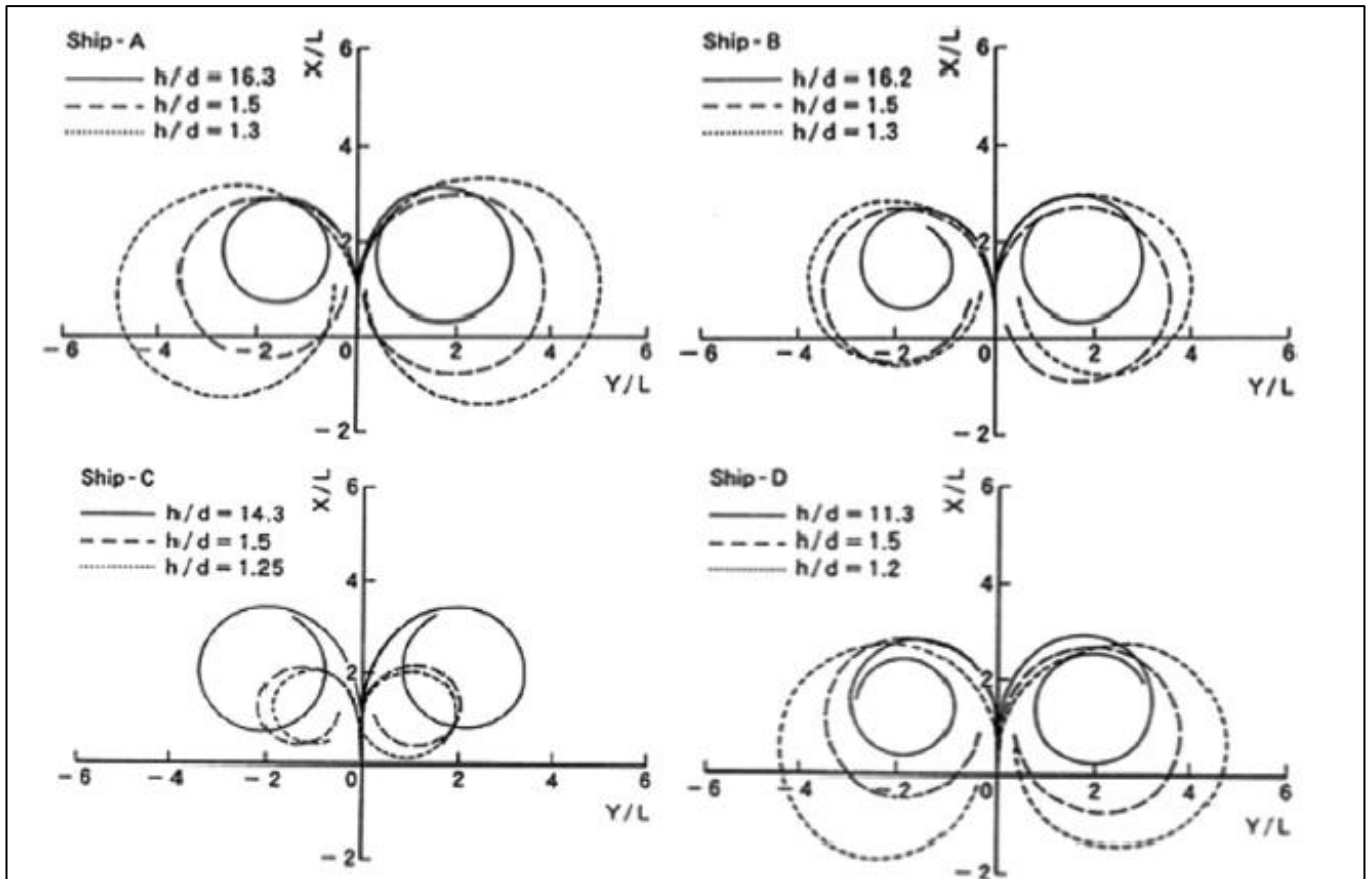

Figure 12: Comparisons of ship trajectories in shallow water and deep water. Source: Liu et al. (2015).

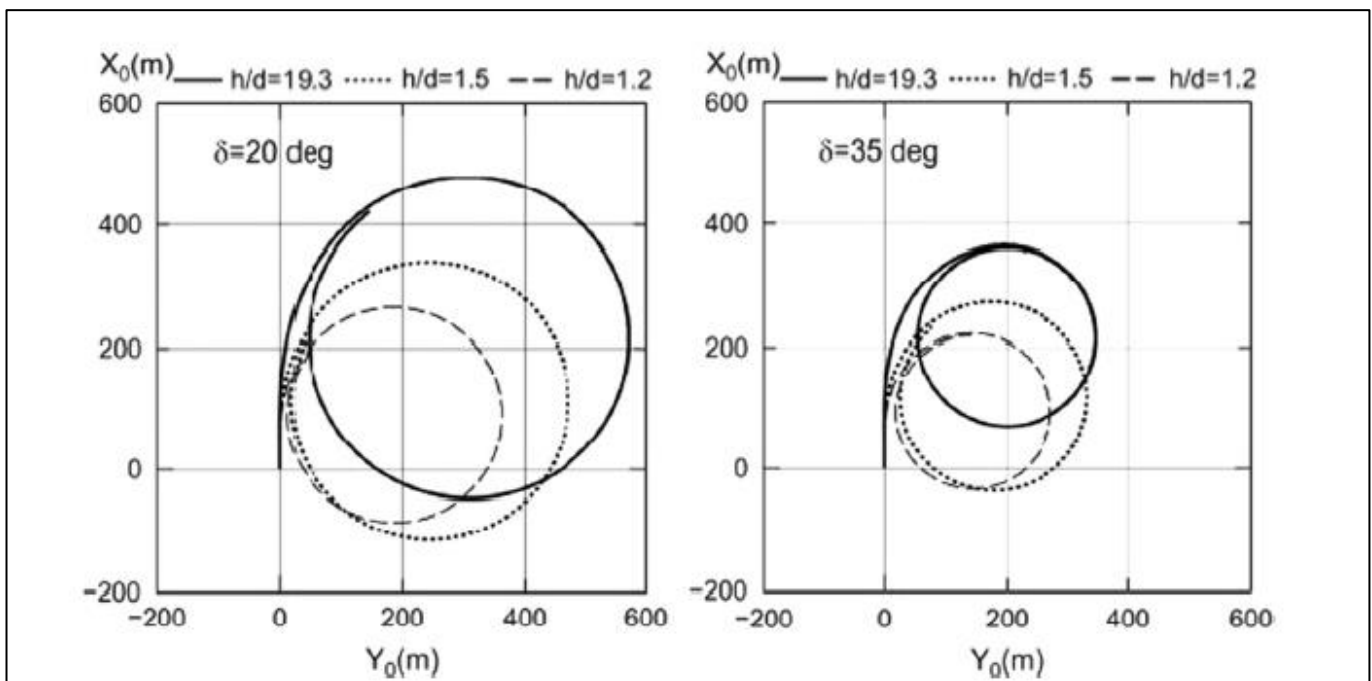

Figure 13: Turning trajectories of a pusher-barge system at rudder angles 20° (left) and 35° (right) Source: Liu et al. (2015).

The shallow-water effects on manoeuvrability become noticeable when  $1.5 < h/T < 3.0$ , and significant for extremely shallow water when  $1.2 < h/T < 1.5$  (Radojčić et al. (2021)).

The stopping characteristics of a vessel may be negatively affected by shallow water, resulting in longer times and distances for stopping due to a greater added mass and reduced thrust (PIANC (1992), Reynolds (1976)). When sailing with reduced draught due to limited water depth and performing a stop manoeuvre, the propeller loading may become very high and air suction to the propeller may occur due to the small distance of the propeller to the free surface and very-low-pressure areas at the propeller caused by the high loading.

### 2.2.5. Safety of navigation

Inland waterway transport is the safest freight transport mode on the European continent (European Commission (2019)). Accidents and human injuries are few and death cases are rare.

The most significant cause for accidents is human error relating to navigation or communication, e.g. when vessels encounter each other or the infrastructure on the waterway (Fig. 14). In addition, however of less importance, technical deficiencies of engines, propellers or rudders are another cause. Difficult nautical conditions like high flow velocities, small radius of curvature or width of the fairway play also a role, in addition to environmental phenomena like storm, wind, reduced visibility, ice flow and high or low water.

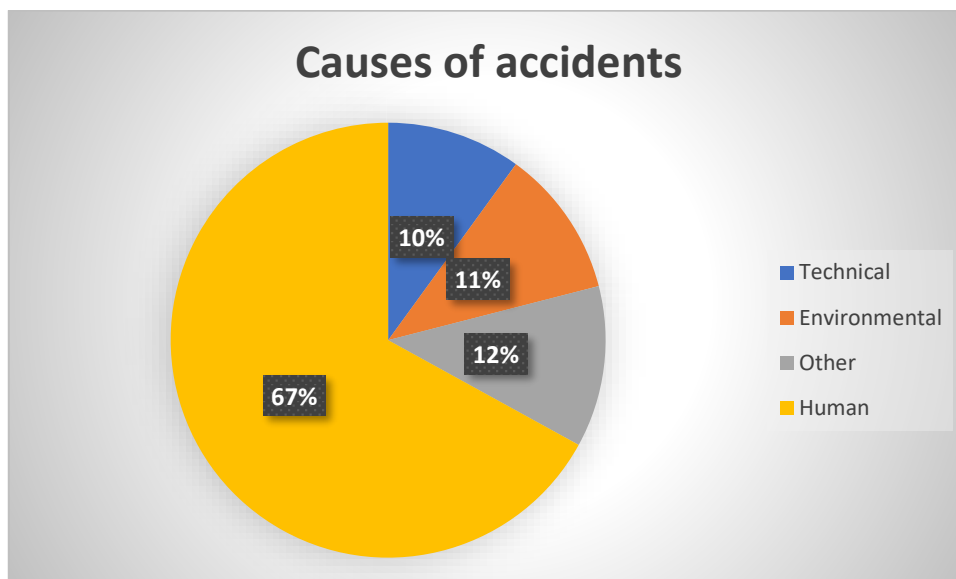

Figure 14: Distribution of accidents due to human, technical, environmental and other reasons in percent related to inland waterway transport on the Danube River in Austria for the years 2000 up to 2006. Reproduced from Schweighofer (2013).

Considering climate change impacts as well as the occurrence of extreme weather phenomena, strong wind, as a specific weather phenomenon, is the most common weather-related cause for accidents (Schweighofer, 2013). The full manoeuvrability of a vessel may be lost. However, in most cases, the consequences are minor material damages, fortunately.

Low water can have a negative impact on the safe operation of a vessel. This is very well demonstrated by an analysis of data obtained from the traffic reports of the German Waterway and Shipping Directorate South-West for the years 2002 up to 2010 (Schweighofer, 2013). The year 2003 was characterised by a very extreme and long-lasting drought, leading to severe disruption of inland waterway transport in Europe. An increase in accidents was observed, mainly caused by the great number of groundings, which rose by approximately 150 % in comparison to the other years (Fig. 15).

Considering the Danube stretch between Straubing and Vilshofen, Wessel and Menzel (2006) performed a comparison between accidents during 2002 and 2003. For 2002 92 accidents and for 2003 111 accidents were

reported. In 2002, characterised by high water levels, collisions with navigation signs were predominant. In 2003, characterised by low water levels, groundings were dominant.

Reasons for increased risks of accidents, in particular grounding, at low-water conditions, may be false estimation of the proper sailing draught of a vessel or underestimation of the risk itself for the sake of maximum utilisation of the cargo carrying capacity left. In addition, the amount of vessels to be operated increases in order to compensate for the limitations in cargo carrying capacity due to low water, contributing to increased traffic density and risk of accidents. Further causes relate to restricted fairway parameters as well as technical issues relating to worsened ship performance as described in the previous sections.

The safety of navigation is not necessarily negatively affected by drought on all waterways or waterway sections. Usually, grounding is encountered mainly in free-flowing sections, where shallows are present and the accident rates seem to be highest.

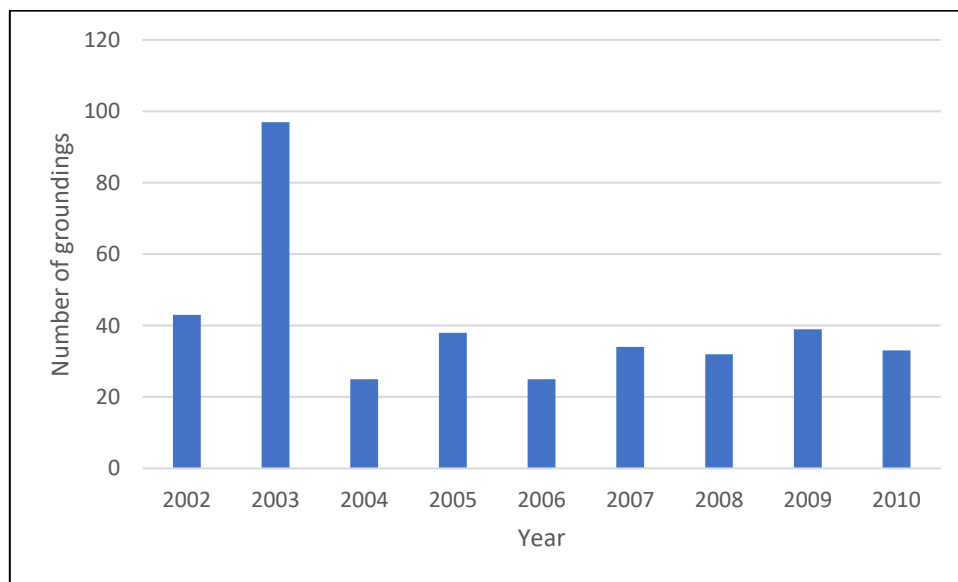

Figure 15: Development of grounding events on the Upper and Middle Rhine within 2002 and 2010. Source: Schweighofer (2013).

### 2.3. Transportation costs

The occurrence of extreme low-water conditions causes an increase of the transportation costs for one ton of cargo. In Fig. 17, the development of water depths of the Rhine at Bingen/Ostrich and the specific transportation costs of a large motor cargo vessel (GMS, bulk cargo) are presented for the years 2002 with moderate and high water levels and 2003 with extremely low water levels in the third and fourth quarter of the year. The specific costs in EUR/t were determined by simulations carried out by DST within the framework of the German KLIWAS Programme (Holtmann and Bialonski (2009)). The cargo and relation considered are bulk cargo and the stretch between Rotterdam and Basel. In the year 2002 and the first two quarters of the year 2003, the transportation costs for one ton of cargo are relatively low due to relatively moderate or higher water levels. However, at extremely low water levels as they were present in the second half of the year 2003, a significant increase in the specific transportation costs is observed. In addition, the vessel cannot be operated anymore for several days due to the limitation of its draught, which is denoted by a limitation of the specific costs in Fig. 16 (e.g. days 220 up to 275). The increase in the specific transportation costs is caused by a reduction of cargo transported per round trip due to low water. In addition, low water results in lower vessel speeds and longer travelling times for round trips. The staff costs, operational costs and capital costs per day have to be applied to a greater number of days of a round trip, increasing the costs per round trip. Higher total costs and less cargo for a round trip result in a significant increase of the transportation costs for one ton of cargo as displayed in Fig. 16.

Negrea (2016) reported for the low water on the Danube in 2015 a reduction of the cargo transported by vessels of the shipping company NAVROM by 30 % from approximately 1300 t to 900 t, compared with normal water level conditions. Larger convoys comprising nine lighters had to be separated into formations of one to two units, resulting in more movements with the pusher and increased number of sailed kms, as well as fuel consumption. In addition to increased transportation costs due to the circumstances mentioned above, significant delays (five to seven days and even more), damage of vessels as a result of grounding and loss of shipment contracts were reported.

The statements mentioned above are also applicable to the development of freight rates in EUR/t. In Fig. 17, the development of cargo transported, the number of shipments and the freight rate of inland waterway transport on the Rhine are outlined for the year 2018, which was characterized by severe low water in the third and fourth quarter. The number of shipments increased in order to cope with the demand for supply, the cargo transported decreased due to lack of floating transportation capacity and the freight rates increased as a result of higher costs, low-water surcharges applied and less cargo carried. According to CCNR (2019 a), the freight rate index for gasoil from the ARA region to destinations on the Rhine increased by 800 % compared with the ones at the end of 2017 and the first half of 2018 (Fig. 18), and the one for dry cargo, metals, and container transport in the Rhine basin (the Netherlands, Belgium, traditional Rhine) increased by approximately 100 % up to 150 % (Fig. 19). More in detail, the freight rates for coal, iron ore and containers increased more strongly during the low-water period than for sand, stones, gravel and building materials, as well as agribulk.

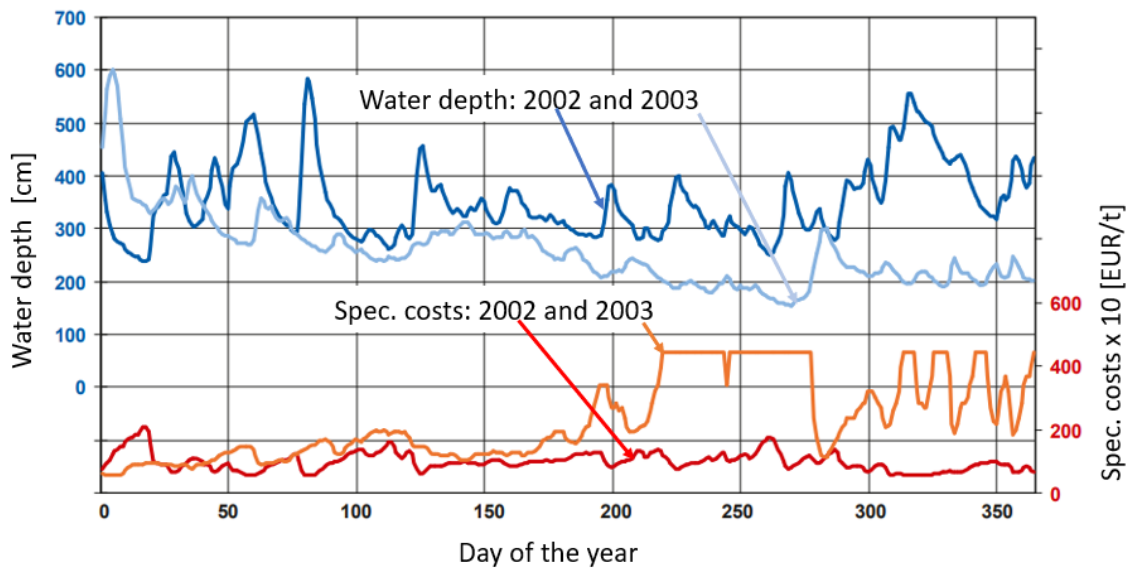

Figure 16: Development of water depths at Bingen/Ostrich and specific transportation costs of a large motor cargo vessel (GMS, bulk cargo) presented for the years 2002 (moderate and high water levels) and 2003 (low water). Reproduced from Holtmann and Bialonski (2009).

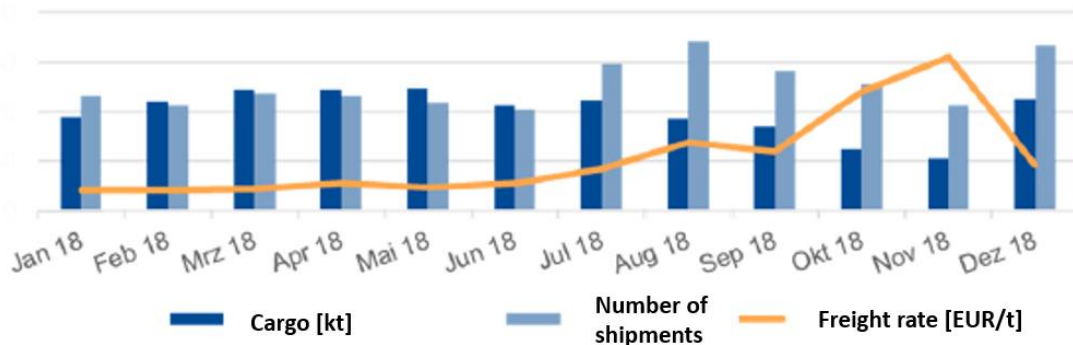
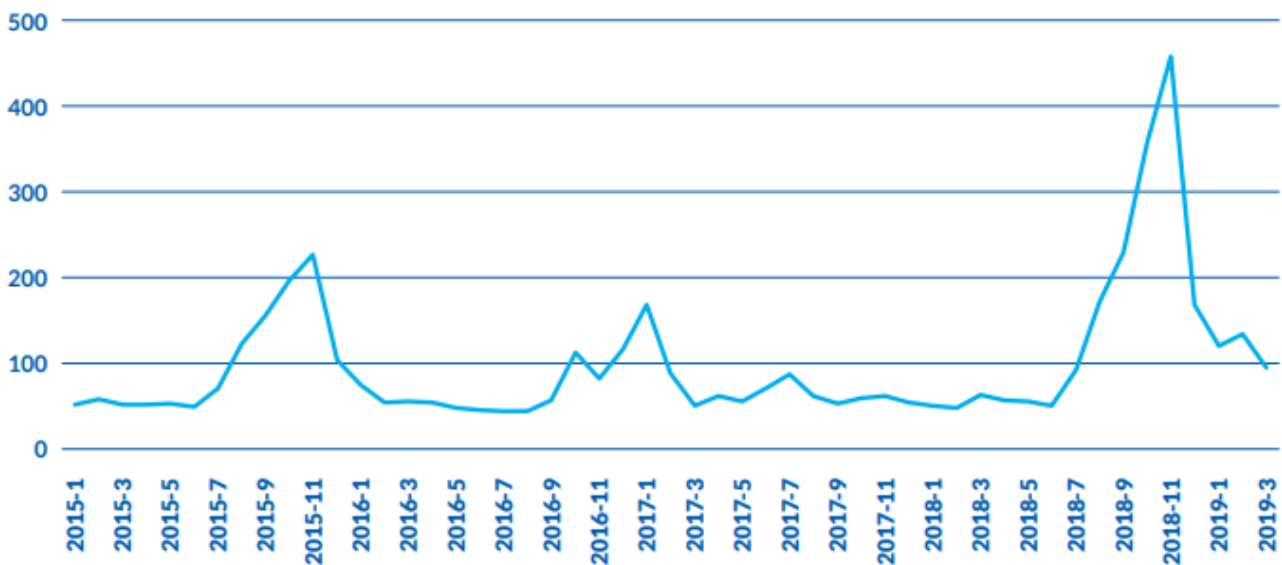

Figure 17: Development of cargo transported, number of shipments and freight rate of inland waterway transport on the Rhine in the year 2018. Reproduced from ZKR – Zentralkommission für die Rheinschifffahrt (2021), source: BASF.

**PJK FREIGHT RATE INDEX FOR GASOIL FROM THE ARA REGION TO DESTINATIONS ALONG THE RHINE (INDEX 2015=100)\***



Source: Calculation CCNR based on PJK International  
 \*Gasoil freight rates including pilotage, harbour and canal dues.

Figure 18: Development of freight rate index for gasoil from the ARA region to destinations on the Rhine (index 2015 = 100). Source: CCNR (2019 a) (calculation of CCNR based on PJK International, gasoil freight rates including pilotage, harbour and canal dues).

**PANTEIA FREIGHT RATE INDEX FOR DRY CARGO, METALS AND CONTAINER TRANSPORT (INDEX 2015 = 100)**

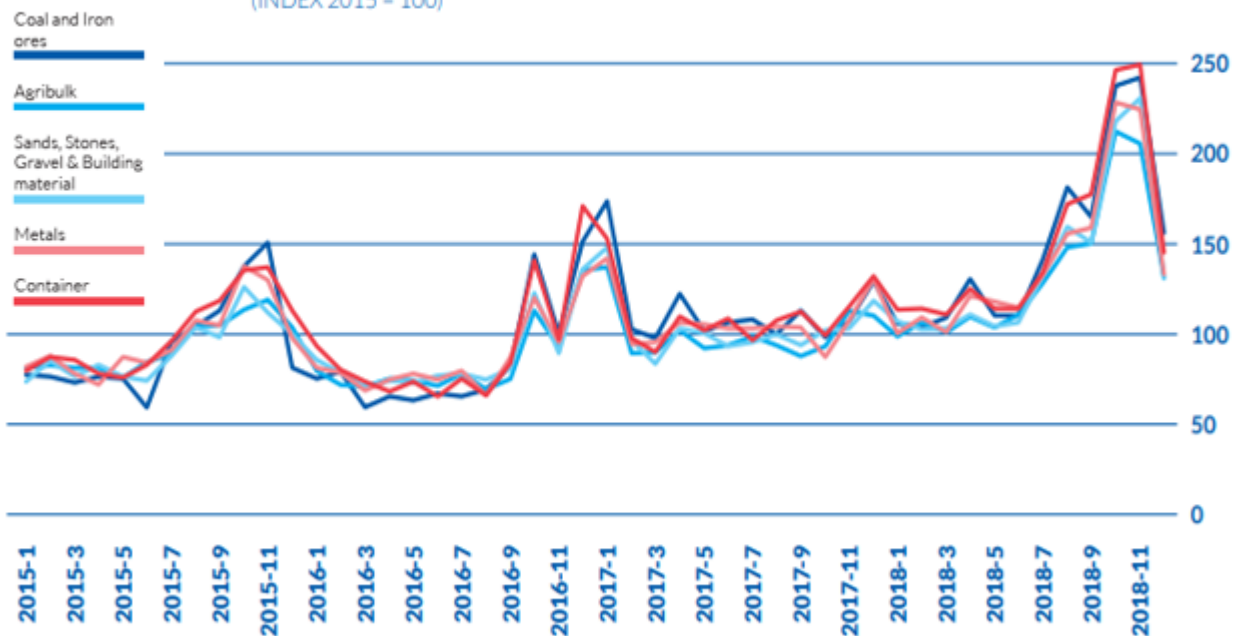

Figure 19: Development of freight-rate indexes for dry cargo, metals, and container transport in the Rhine basin (the Netherlands, Belgium, traditional Rhine) between 2015 and 2018 (index 2015 = 100). Reproduced from CCNR (2019 a).



## 2.4. Modal shift

Extreme low water results in a decrease of the service quality of inland waterway transport due to increased freight rates, eventually longer transportation times including interruptions of transport, increased administrative and financial burden with respect to organisation of more shipments, transfer of goods to other vessels and consideration of alternative means of supply, e.g. per road or rail transport. In the worst case, no satisfactory supply of goods and raw materials can be realised, resulting in severe losses in production, see next section.

As a consequence, the cargo will be shifted from waterways to rail or road, causing a reduction of the share of inland waterway transport in the modal split. This holds in particular for market segments which are in a strong multimodal competition, e.g. container transport. The low water period in the second half of the year 2018 resulted in a decrease of container transport by 16 % in the first half of 2019 compared with 2018 (ZKR (2021)). Severer is the fact that once cargo has been moved to rail or road, it will not come back easily due to lost confidence in the reliability of inland waterway transport, except noticeable restrictions in the service quality of the other modes of transport occur, e.g. in the first half of 2018, the interruption of the rail connection along the Rhine axis at Rastatt caused a cargo shift from rail to inland waterways.

Although, rail and road benefit from the modal shift at low water, they are not necessarily capable of fully satisfying the supply demand of the industry due to limited free capacities which will be challenged even more as a consequence of steadily increasing demand for transportation and political objectives to shift cargo and passengers from road to rail. E.g., the year 2003 was characterised by many months of drought and low water levels, leading to less cargo transported and more vessel movements in order to satisfy the demand for transportation. The limitation in transport capacity led to a shift of cargo from water to railways. However, the railways could not cope with the cargo shift sufficiently. Bernd Malmström, at that time CEO of Deutsche Bahn Cargo AG, justified in November 2003 in an interview with the DVZ (Deutsche Verkehrs-Zeitung) the delay in delivery and the bad service of the Deutsche Bahn amongst others with the 'low waters of the rivers, which claimed all free reserves available at short notice' (Jägers (2005)).

More importantly, given the current and foreseen policy changes at the EU – e.g. the Green Deal – and national levels, the IWT sector will not only need to compete, but also to collaborate with the land-transport sector, in particular the rail sector. Multimodality already is the norm in some geographical regions and/or for some commodities at the EU level, and it will become so for others in the coming period. The IWT sector needs to adapt part of its components in order to ensure a smooth and fast transport of goods, but also its loading and unloading operations in multimodal hubs. Additionally, while the more common (and preferred) types of transport operations are those involving long(er)-distance trips, in the future there may be a need for a more fragmented type of services, with an increased number of stops along a return trip. Consequently, the climate resilience changes of IWT ships also need to include these operational and commercial aspects. Part of them, such as the loading capacity, have already been referred to in the document.

And while the (multi)modal shift will certainly be focused on the freight transport, in some cases, especially in and around the big riverine cities, the IWT sector can also witness an increase in the passenger transport, which will put further stress on the overall riverine transport operations. The IWT sector will thus start more and more facing similar challenges to that of the rail sector, which needs to prioritise one type of transport operations over another at different moments in time, with the resulting impact on both vessels' and infrastructures' adaptations required.

## 2.5. Economy

The occurrence of extreme low water can have serious impacts on the economy of the EU with major inland waterways and industrial production.

In the second half of the year 2018, the Rhine was characterised by very low water levels, leading to a significant drop of cargo transported (Fig. 20), exceeding even the drop due to the financial crisis in 2008, 2009 and 2010. In addition to low water, negative impacts resulting from the economic contraction in the second half of 2018 played also a role, however, of less importance (CCNR (2019 a)).

Logistical chains, notably for the delivery of raw materials (iron ore, coal) and for the delivery of final products of the chemical and petrochemical industry, were heavily disturbed (Fig. 21).

According to the Kiel Institute for the World Economy, the disturbances in logistical chains curbed the growth rate of industrial production in Germany in the third and fourth quarters of 2018 significantly (Fig. 22, CCNR (2019 a), Ademmer et al. (2019)). For the third quarter 2018, the Kiel Institute estimates a decrease of the German industrial production by 1.9 billion Euro due to low-water levels on the Rhine. In the fourth quarter of 2018, the industrial production was impacted by low water periods also with a time lag. This “lag effect” can be explained by the fact that raw materials, such as coal, iron ore, but also petrochemical commodities, are input factors in the entire production process of an economy. The loss of industrial production due to this lag effect amounted to 1 billion Euro in the fourth quarter of 2018, while the loss due to the low water levels in the fourth quarter of 2018 itself amounted to another 1.9 billion Euro (= 2.9 billion Euro in total for the fourth quarter of 2018). Detailed evaluations of the CCNR with respect to the monthly impact of the low water on the German industrial production are presented in Fig. 23. In total, the production losses in the third and fourth quarters of 2018 amounted to approximately 4.7 billion EUR corresponding to 0.63 % of the entire German industrial production (ZKR (2021)).

Another study carried out in the Netherlands by Streng et al. (2020)), arrives at lower values for the total losses resulting from the impact of low water in 2018 on inland waterway transport and shippers (transport, production, storage). In the Netherlands, the financial losses were estimated to 295 million EUR and for Germany 2.4 billion EUR. The impact on the economy is very significant also in this study. In Table 3, the impact of this low water on the production of different organisations is presented (Streng et al. (2020)). The sectors affected were construction/building, chemistry and steel production. Two companies gave a concrete estimate of their production losses: ThyssenKrupp lost approximately 100 million EUR and BASF even 250 million EUR, resulting in the construction of a dedicated low-water vessel for BASF in order to avoid such significant losses in the future (see Chapter 4). Many shippers expressed their intention to shift their cargo permanently from waterways to other modes of transport and to increase their storage capacities. Some representatives of the producing industry mentioned even that the continuation of business at the production locations along the Upper Rhine are critically evaluated due to the uncertain developments of supply in the future (ZKR (2021)).

According to BfG (2019), in 2018, the general provision of fuels was limited, causing very high fuel prices at petrol stations, as well as a part of the strategic energy reserves of the German government had to be released. Several power plants along the Rhine had to reduce their energy production, e.g. the nuclear power plant Philippsburg, as well as the coal-fired power plants Bergkamen, Walsum and Mannheim.

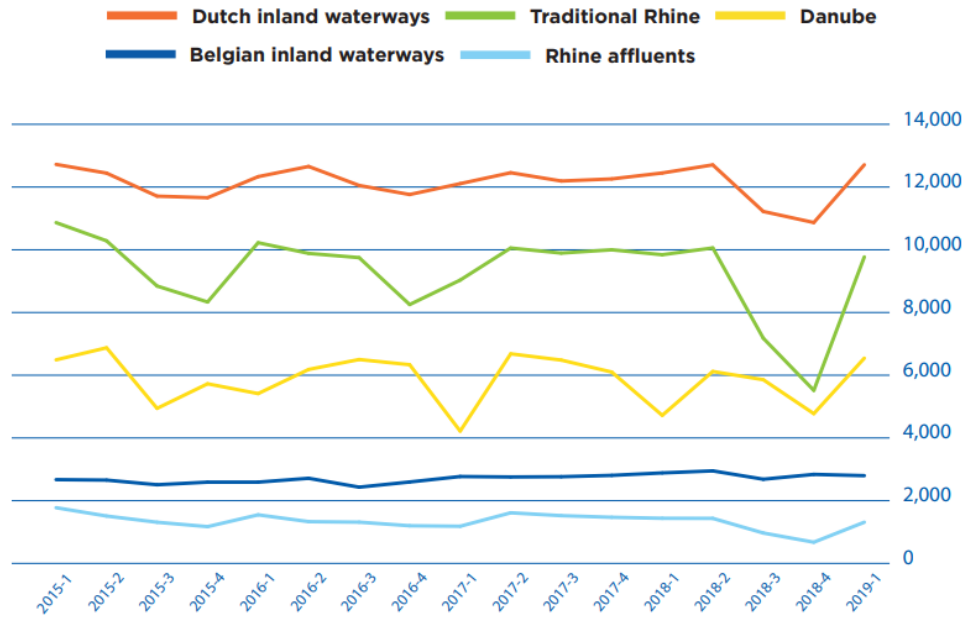

Figure 20: Development of transport performance in million tkm on European inland waterways between 2015 and 2019. Source: CCNR (2019 b).

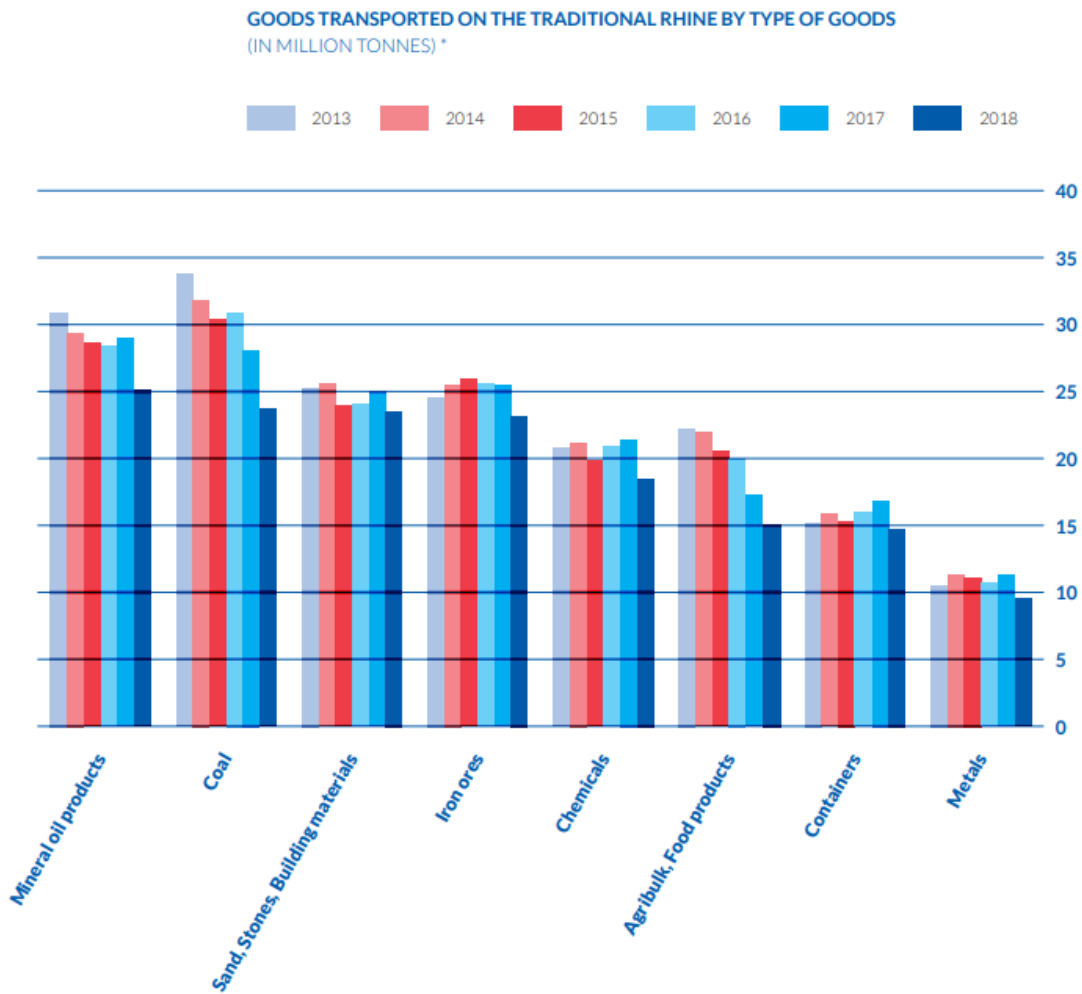

Figure 21: Goods transported on the traditional Rhine by type of goods in million tonnes, presented for the years 2013 up to 2018. Impact of low water during the year 2018 on the amount of transported goods. Source: CCNR (2019 a).

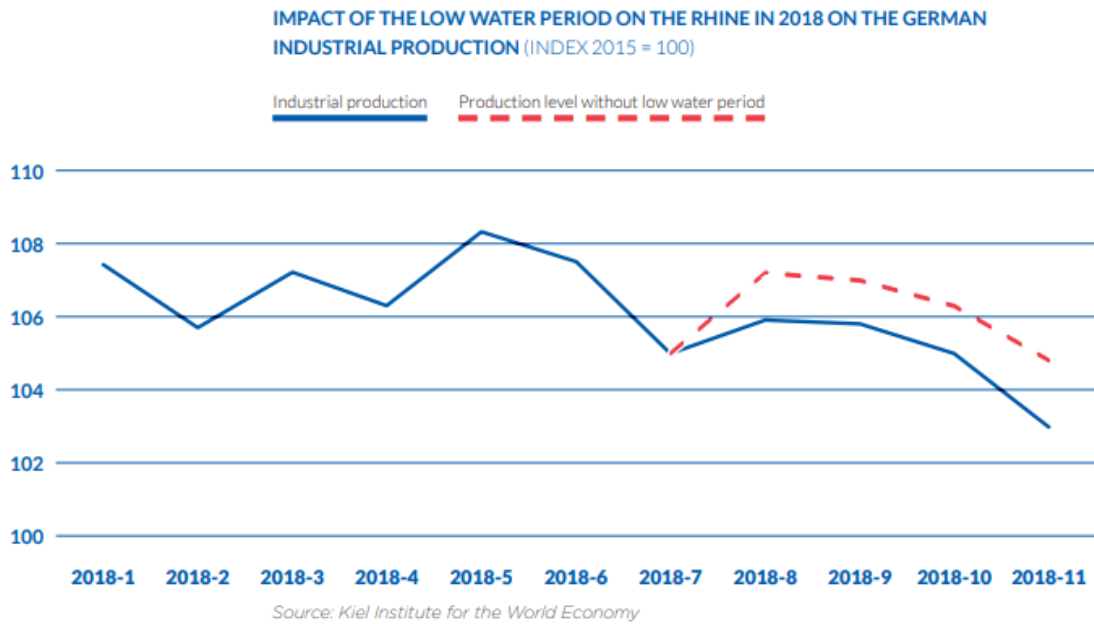

Figure 22: Impact of low water period on the Rhine in 2018 on the German industrial production. Source: CCNR (2019 a).

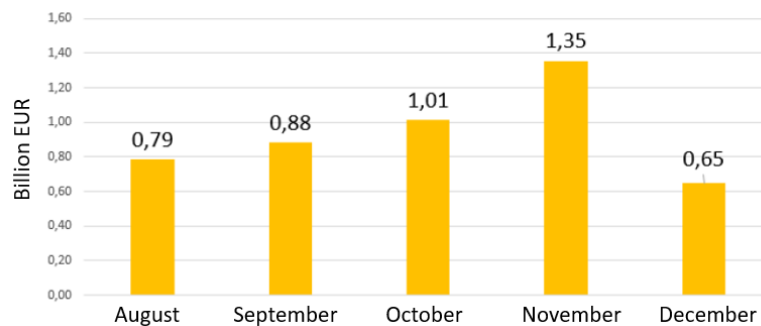

Figure 23: Impact of low water on the Rhine in 2018 on the German industrial production. Losses in billion EUR in the months August up to December, estimated by the CCNR. Reproduced from ZKR (2021).

Table 3: Impact of low water on the Rhine in 2018 on the production of different organisations. Reproduced from Streng et al. (2020).

Organisation	Sector	Costs/production
Strukton	Construction	Postponement of production
BTE	Construction	Suspension of production
Nouryon	Chemistry	-25 % of production
BASF	Chemistry	Total: 250 million EUR loss
Solvay	Chemistry	Reduction of production
Vestolit	Chemistry	Reduction of production
Ineos	Chemistry	Reduction of production
Covestro	Chemistry	Reduction of production
Evonik	Chemistry	Reduction of production
ThyssenKrupp	Steel	Total: 100 million EUR loss
ArcelorMittal	Steel	Reduction of production

From a historical perspective, the low water in 2018 was not the severest one, although the impact on the economy was very significant as described above. In Fig. 24, the number of days per year with a discharge  $Q < 783 \text{ m}^3/\text{s}$  (= equivalent low water discharge) is presented for Kaub on the Middle Rhine, including 30-year moving averages. It can be seen that much longer periods with a discharge below  $783 \text{ m}^3/\text{s}$  than in 2018 occurred in the past. In 2018, the number of days amounted to 107, while in 1971 the number of days was 146. In general, in the past 200 years, such low water events occurred regularly, although in the last 50 years these events have become less and shorter lasting. However, also in the light of no climate change such events will happen in the coming decades. Accounting for climate change impacts on the hydrology, it is expected that such events will occur more often in the future (BfG (2019)), e.g., at Lobith on the Rhine, the low water event of 2018 is projected to take place every 10 to 20 years instead of every 60 years till 2050 (WHdry 2050, van der Mark (2021), Kramer et al. (2019)). The impact of the past longer lasting low-water events on inland waterway transport was not that strong as in 2018 as in those times the vessels used were smaller and less vulnerable to water level changes than the much larger new ones which entered operation in the recent past years (ZKR (2021)). This holds also for a part of the pusher and tug fleet on the Danube which displayed initial design draughts between 1.1 m and 1.5 m in the 1960s and 1970s (Schiffahrts-Museum Regensburg e.V. (2004), Radojčić et al. (2021)), while the draughts of most later designed and today's pushers vary between approximately 1.5 m and 2.2 m, allowing for higher propulsive power, larger convoys and, thereby, for greater energy and cost efficiency of the transport at normal water level conditions.

Considering the possible severe impacts on the economy and the inland waterway transport sector due to the currently existing risk of low water which is even increased by climate change in future, it is necessary to re-evaluate the logistical concepts in place today, including the size and design of vessels (ZKR (2021)). Such new concepts will contribute to the reduction of the vulnerability of inland waterway transport to low-water events, and they can be implemented relatively fast in dedicated single cases. However, in order to reduce the vulnerability of the entire fleet, dedicated infrastructure measures, starting with proper maintenance of waterways on short term, have to be considered for improving the climate resilience of inland waterway transport on the long term.

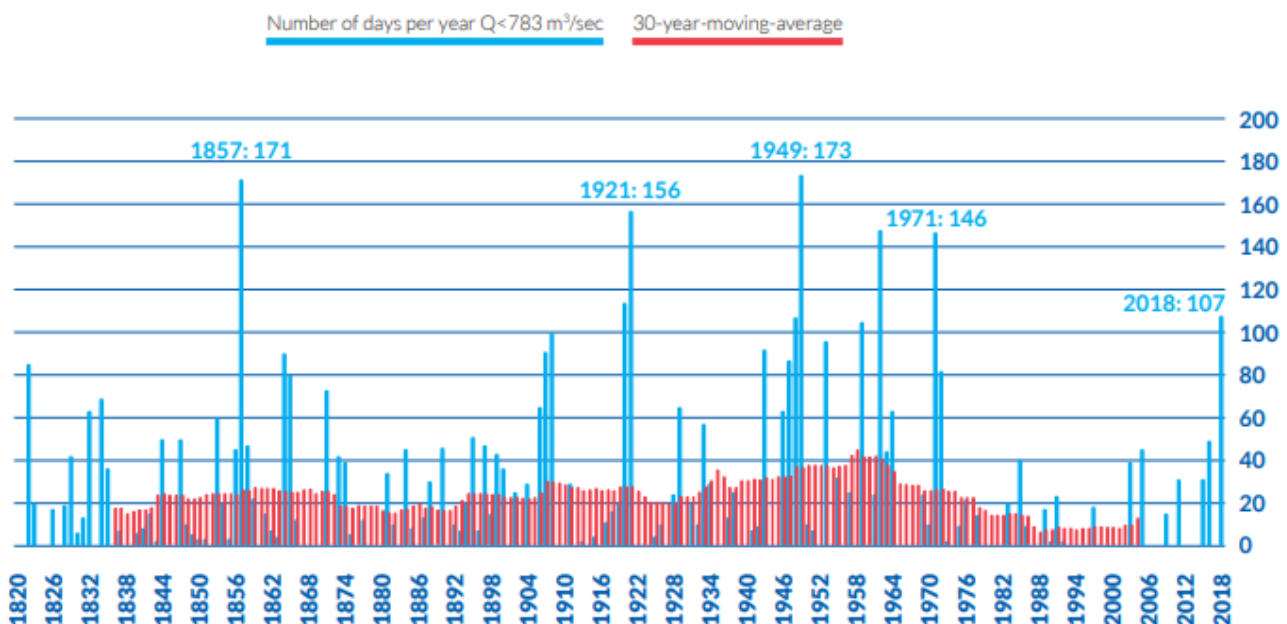

Source: Federal German Office of Hydrology.  
\*Corresponds to a water level of 78 cm (equivalent water level).

Figure 24: Number of days per year with a discharge  $Q < 783 \text{ m}^3/\text{s}$  (= equivalent low water discharge) at Kaub, Middle Rhine, including 30-year moving averages. Source: CCNR (2019 a).

## 3. Options for shallow-water vessels

### 3.1. Propulsion systems

According to Radojčić et al. (2021), the efficiency of an ideal propeller  $\eta_i$  (=an actuator/propulsor with an infinite number of blades and no frictional or rotational losses) can be given as function of the thrust loading coefficient  $C_{Th}$  by:

$$\eta_i = 2 / (1 + (1 + C_{Th})^{0.5}).$$

The thrust loading coefficient is defined as:

$$C_{Th} = T / (0.5 \cdot \rho \cdot (V_A)^2 \cdot D^2 \cdot \pi / 4),$$

where  $T$  is the propeller thrust in N,  $\rho$  is the density of water in  $\text{kg/m}^3$ ,  $V_A$  is the speed of advance of the propeller in m/s ( $V_A = V \cdot (1-w)$ , where  $V$  is the ship speed in m/s, and  $w$  is the wake fraction coefficient), and  $D$  is the propeller diameter in m.

The evolutions of the ideal propeller efficiency and the open water efficiencies of different propulsion solutions are shown as functions of the thrust loading coefficient in Fig. 25. An increase of the thrust loading coefficient results in a decrease of the open water propeller efficiency and greater energy losses. An increase of the thrust loading coefficient can be caused by a high thrust, e.g. due to a high resistance resulting from low water or pushing a convoy, a low ship velocity, e.g. a pusher pushing a big convoy, or a small propeller diameter, e.g. installed in order to be capable of operation at low water conditions. In general, it may be concluded that operation under low water conditions will lead to an increase of the thrust loading coefficient, and, therefore, the open water efficiency will be reduced. The reduction of the open water efficiency can be overcome by the arrangement of multiple propulsors, e.g. usage of 3 propellers instead of 2 where the thrust is distributed to more devices, or technical solutions for provision of additional thrust, e.g. Kort nozzles, being very effective at high thrust loading coefficients.

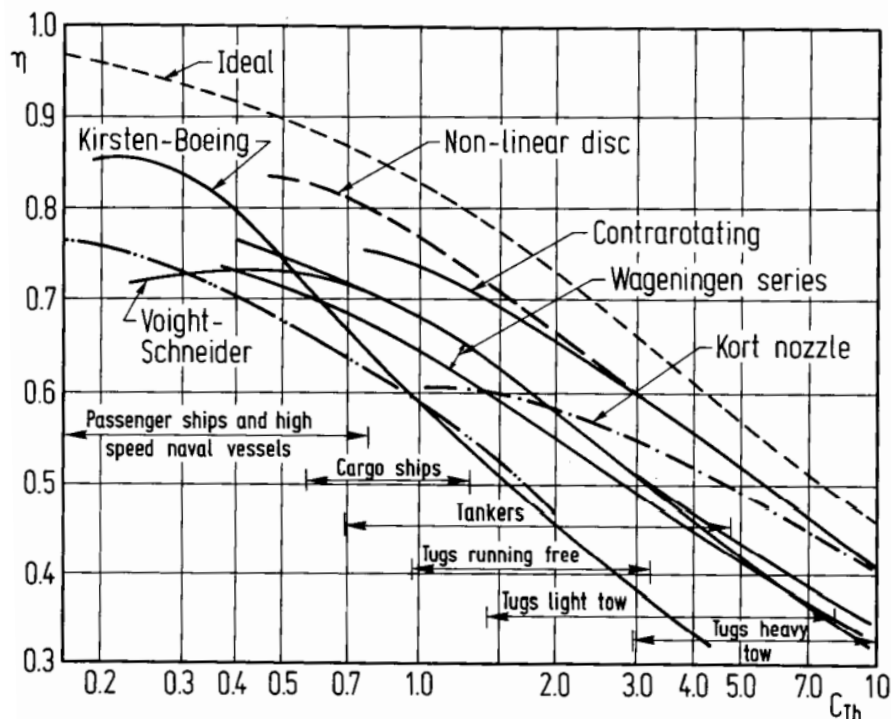

Figure 25: Ideal efficiency and open water efficiencies of different propulsors presented as function of the thrust loading coefficient  $C_{Th}$ . Source: Breslin and Anderson (1994).

In addition to the losses in efficiency, a high propeller loading may result in cavitation and ventilation, preventing a proper operation of the ship, as well as causing possible damage to the propulsion and rudder devices.

Ramne et al. (2020)<sup>4</sup> considered different propulsion concepts with respect to their suitability for operation at low water conditions. They state that with ducted propellers, as the most common propulsion solution, a power of up to about 400 kW/m<sup>2</sup> ( $P_D/(D^2 \cdot \pi / 4)$ ) and a thrust at bollard pull conditions of up to about 70 kN/m<sup>2</sup> ( $T/(D^2 \cdot \pi / 4)$ ) can be transmitted into the water, resulting in a physical lower limit of the propeller diameter. Reducing the thrust load by increasing the cross-sectional area leads to a higher propulsive efficiency. According to these principles, the propeller diameter is usually selected larger than the empty draught of the ships. Without sufficient cargo, these ships are ballasted with a trim by the stern. For large Rhine vessels, propeller diameters of about 1.75 m for single screw ships and 1.6 m for twin screw ships are common. Only for ships wider than 11.4 m and cabin ships with a small draught, the propulsion is distributed over more than two propulsion units. Within the STREAMLINE<sup>5</sup> project, an inland ship with 11.4 m width and six podded propulsors with a diameter of 1.4 m was investigated but not built. Further optimisation for newbuilt ships allows very small draughts in combination with high propulsive efficiency.

Depending on the shape of the aft body and the propeller diameter, every inland ship has a minimum draught for safe navigation. If the draught is too low, ventilation occurs and the required thrust cannot be generated. Modern inland ship designs with optimised tunnel geometry preventing ventilation allow a minimum draught of approximately 75 % of the propeller diameter (Figs. 26 and 27, propeller tunnel, propeller tunnel with deep apron, flex-tunnel active). These ships can slowly accelerate and gradually remove air from the propeller tunnel. At a certain speed the propeller works free of ventilation. The following figure shows the minimal draught for different hull-propulsion setups based on multiple tests performed in the model basin at DST.

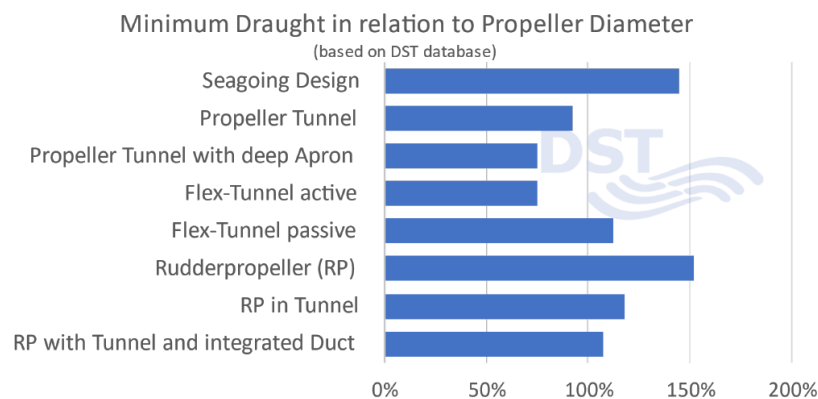

Figure 26: Comparison of propulsion concepts and draught-requirements in relation to the propeller diameter. A minimum of draught of e.g. 150 % means a draught equal to 1.5 x propeller diameter. Source: Ramne et al. (2020).

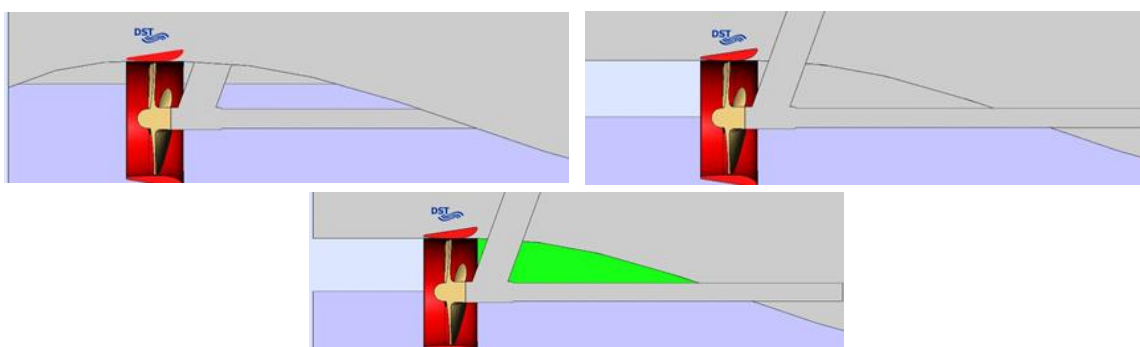

Figure 27: Different propulsion solutions for operation in shallow water. Top, left: propeller in tunnel; top, right: propeller in tunnel with deep apron; bottom: propeller with flex tunnel, active. Source: Guesnet et al. (2021), DST.

<sup>4</sup> <https://www.novimove.eu/download/d4-2-concepts-and-selection-of-innovative-novimove-concepts/>

<sup>5</sup> <https://cordis.europa.eu/project/id/233896/de>

### 3.2. Bow thruster

In Fig. 28, a sketch of the open water characteristics of a propeller is shown for one pitch ratio  $P/D$  where  $P$  is the propeller pitch and  $D$  is the propeller diameter. The graph shows the development of the open water efficiency  $\eta$ , the torque coefficient  $K_Q$  and the thrust coefficient  $K_T$  as a function of the advance coefficient  $J$  (which is a function of the ship speed, the rate of revolutions and the propeller diameter). An advance coefficient of zero corresponds to a ship speed equal to zero. The ship speed is equal to zero when the vessel pulls a bollard or when it starts moving from rest. At the bollard pull condition ( $J = 0$ ), the thrust coefficient  $K_T$  is greatest, resulting in a very high propeller thrust. As the propeller loading is a function of its thrust, the respective loading is also very high. In shallow water at very small draughts of the vessels, the great propeller loading can cause air suction and thereby a loss of thrust, preventing the ship of starting moving in the worst case. This can be overcome by reducing the thrust and load of the propeller using a bow thruster which creates an additional thrust, compensating the lower thrust of the propeller.

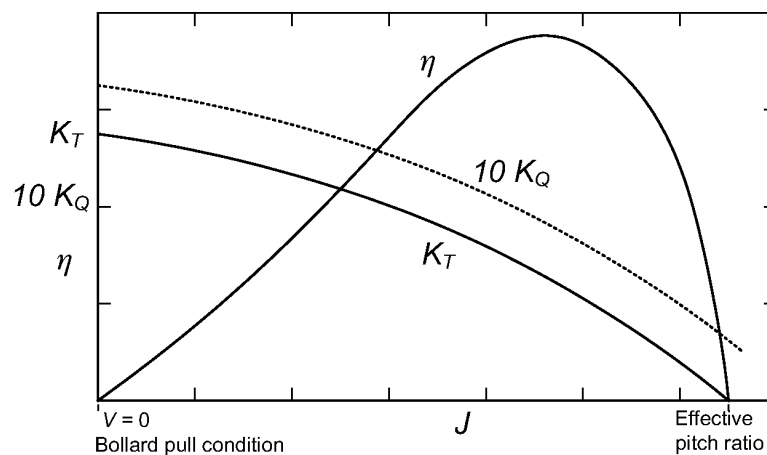

Figure 28: Sketch of open water propeller characteristics. The thrust coefficient  $K_T$  is highest at the bollard pull condition which corresponds to a ship speed  $V = 0$  km/h. Source: Molland et al. (2017).

In shallow waters, the bow thruster improves the manoeuvring behaviour of a vessel, which usually becomes worse with decreasing water depth, as well as the stopping distance and time, increasing with decreasing water depths, will be reduced due to the additional thrust of the bow thruster acting in opposite direction of the movement of the vessel and braking it. This issue is well illustrated by the following (Ramne et al. (2020)): The stopping capacity of a vessel is prescribed in the European Standard laying down Technical Requirements for Inland Navigation vessels (ES-TRIN 2021). In still water, for vessels and convoys with a length of up to and including 110 m, the maximum distance to stop from 13 km/h is 305 m. For longer vessels and convoys, 350 m is the maximum stopping distance. The prescribed test requires 70 – 100 % of the ship's deadweight. However, at extremely low draught the thrust loss due to ventilation may be more critical than the mass inertia of the loaded ship. For example, model tests of a large Rhine ship with two ducted propellers of 1.40 m diameter with active flex tunnels showed a stopping distance of less than 200 m at 2.80 m draught and almost 500 m at 1.05 m draught. Here powerful bow thrusters with a stopping channel have to be used for stopping.

For the improvement of the manoeuvring, stopping and acceleration behaviour in shallow waters, different bow thruster solutions are available.

In Fig. 29, different pump-jets, initially developed as bow thrusters, are shown. They consist of a mixed-flow pump placed in a special volute casing that can rotate about its vertical axis, enabling steering throughout 360 degrees. The water is drawn into the casing below the hull and it is expelled through the outlet nozzle. Advantages are applicability to very shallow draught vessels, good manoeuvrability, robustness (even grounding is allowed) and reduced jamming. The disadvantages of the pump jets are their relatively high costs and low efficiencies.





Figure 29: Schottel Pump-Jet and Veth's Compact-Jet. Source: Radojčić et al. (2021).

Similar results may be obtained with the so-called 360-degree-steerable steering-grid and 4-channel thrusters which are primarily intended to be used as bow thrusters, while the abovementioned pump jets may be used for propulsion too. The 4-channel thrusters (Fig. 30) have starboard (SB), portside (PS), backwards oriented (BO) and forward-oriented (FO) channels; the first two are used for steering, the third provides additional thrust for (emergency) propulsion and the fourth enhances stopping. Channel thrusters are well suited to low draught vessels and may be mounted in the hull or outside of the hull in a gondola.

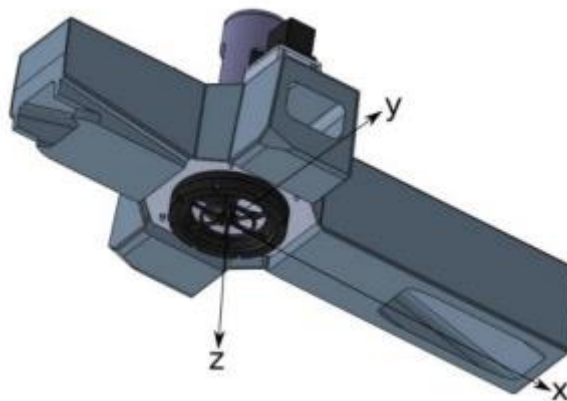

Figure 30: Bottom view of a model of a 4-channel thruster. Source: Peeters et al. (2020), Radojčić et al. (2021).

### 3.3. Adjustable tunnel (flex tunnel)

Referring to Section 3.1, the adjustable tunnel (Fig. 31) is considered more in detail in the following due to its positive impacts on operation at shallow water conditions and energy efficiency at normal sailing conditions.

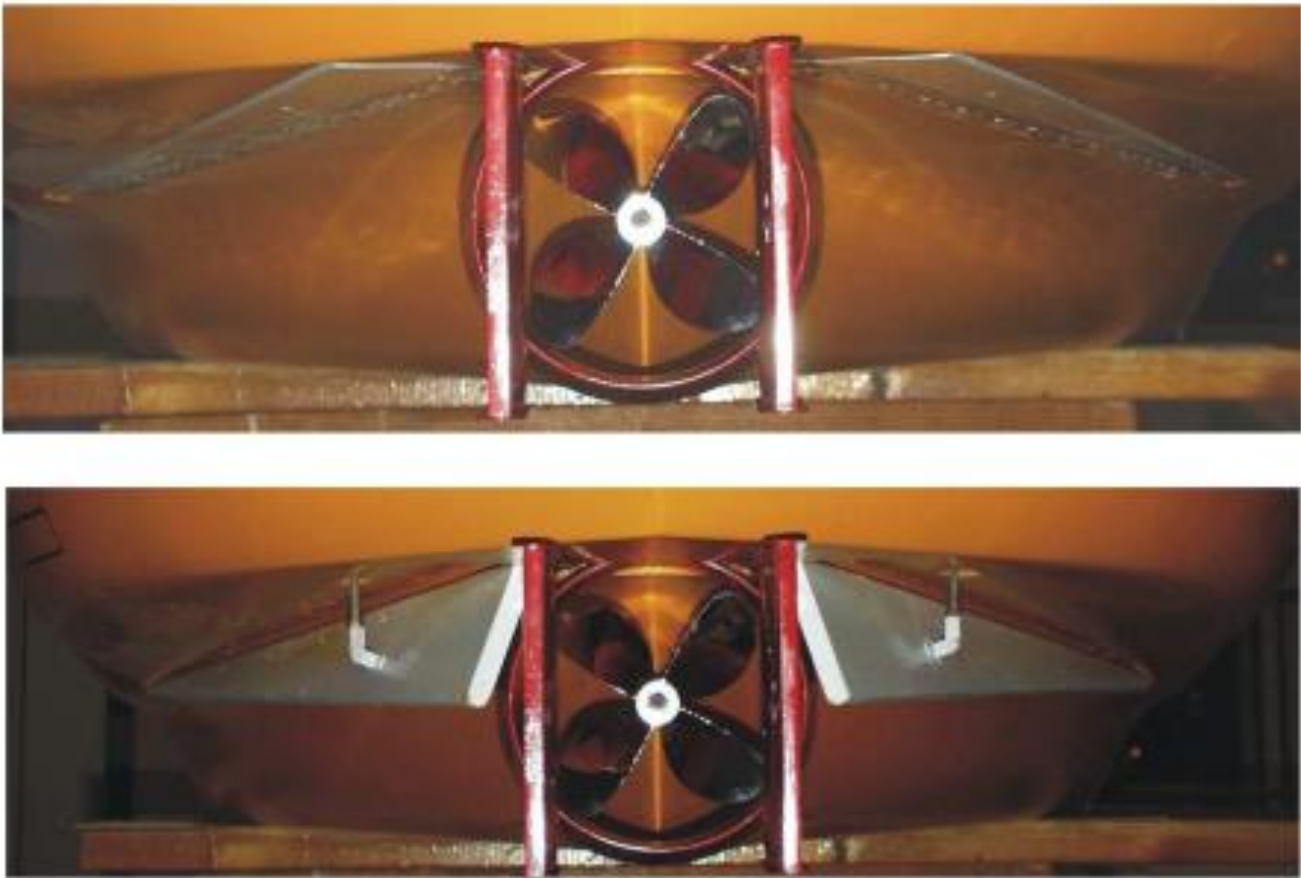

Figure 31: Adjustable tunnel aprons (in functional model scale) - to be retracted into the hull if the ship utilises its full draught in deep water (above) - to be extracted when the ship operates with small draught in low water (below). Source: DST, ECCONET (2012).

At extremely low water levels and corresponding draughts, the risk rises that the propeller is not fully immersed anymore. This results in a considerable loss of propulsion efficiency. A reasonable approach to solve this problem is to build a so-called “tunnel” in the range of the propeller shaft. Such a form of underwater hull prevents the non-desirable air suction into the rotating propeller and hence enables a favourable water inflow also at low water levels and small draughts. According to a very rough estimate, approximately 90 % of inland self-propelled vessels and push boats on European waterways are already equipped with firm tunnels. Such a firm tunnel with a constant geometry brings good effects in low water conditions but on the other side – in case of favourable water depths – its presence causes negative effects on the propulsion performance. This happens due to the hindering of a free water flow into the propeller disc from aside over the lower edge of the tunnel aprons. From a hydrodynamic point of view, an installation of adjustable tunnel aprons seems to be a good solution to overcome losses in propulsion effects in operation of inland vessels at fluctuating water depths. Applying this adaptation measure, the water levels of navigability can be extended by around 30 cm, e.g. from 110 cm to 80 cm for Gustav Königs type vessels or from 135 cm to 105 cm for GMS type vessels and coupled convoys, compared with ships without a firm tunnel. (ECCONET (2012)). Compared to vessels with “firm tunnel” the benefit is in the reduced power demand while the adjustable tunnel is inactive (folded away).

The flex tunnel (adjustable tunnel aprons) was developed at the DST (Development Centre for Ship Technology and Transport Systems) in Germany. The developers Joachim Zöllner (DST) and Steffen Augspurger (Heinz Mertz & Co.

Schiffahrt) were awarded the „Innovation Price Inland Navigation” of the Allianz Esa in 2017<sup>6</sup>. It was patented already in 2005. Further developments carried out by Van der Velden (Fig. 32), now Damen Marine Components (AFAIK), owning the exclusive licence for this product, made it a commercial product in current ship design. Several vessels use this technology, e.g. “Rhenus Duisburg”, “Ecoliner<sup>7</sup>” and the BASF tanker to enter operation in 2022 (Chapter 4).

The flex tunnel is applicable mainly to new-buildings. For the integration of the flex tunnel, the total hull design should be customised. Therefore, it is not suited to existing vessels<sup>8</sup>. However, if a part of the aft ship is intended to be replaced then it could be considered also as a part of a retrofit solution.

Damen lists the following advantages<sup>9</sup>:

- propulsion efficiency improvements of approximately 10 %;
- less resistance;
- considerable fuel saving;
- good manoeuvring at low speed and shallow draught;
- smaller propellers and lower engine capacity required;
- longer operational at shallow draught.



Figure 32: Flex Tunnel of Van der Velden. Left: retracted into the hull if the ship. Right: extracted for operation with small draught at low water depths. Source: Damen<sup>10</sup>

### 3.4. Weight reduction

According to ECCONET (2012), hulls of commercial conventional ships are built of so-called “mild steel” – steel plates and profiles of standard quality (mechanical characteristics and chemical components) dedicated to shipbuilding. The hull structure must satisfy the prescribed strength requirements. However, standardised structures (cross sections, bar scantlings and plate thicknesses) have been usually developed for minimum building costs but not for minimum weight. The mild shipbuilding steel is characterised by relatively low costs and high durability compared to other materials, being of importance especially when having in mind that the exploitation period of an inland waterway vessel is 50 years or even more (Radojčić et al. (2021)). Therefore, the hull weight has not changed much over time. However, there are some technical solutions existing having some potential for weight reduction, although most of them will be associated with a significant cost increase.

<sup>6</sup> <https://www.dst-org.de/innovationspreis-fuer-flex-tunnel-fuer-joachim-zoellner-und-steffen-augspurger/>

<sup>7</sup> <https://archive.damen.com/en/news/2015/03/first-two-van-der-velden-flex-tunnel-systems-sold>

<sup>8</sup> <https://www.damenmc.com/en/products/energy-saving/energy-saving-systems/flex-tunnel>

<sup>9</sup> <https://www.damenmc.com/en/products/energy-saving/energy-saving-systems/flex-tunnel>

<sup>10</sup> [https://www.damenmc.com/-/media/damen/vandervelden/products/energy-saving/flex-tunnel/downloads/flex\\_tunnel\\_system\\_nl.pdf](https://www.damenmc.com/-/media/damen/vandervelden/products/energy-saving/flex-tunnel/downloads/flex_tunnel_system_nl.pdf)

In INBAT (2005), a variety of different light weight solutions was already investigated, with respect to their applicability to inland waterway vessels, comprising different materials, sheet rolled form metal profiles in combination with light weight Polyurethane foam, composite steel and Elastomer sandwich constructions, as well as the so-called “I-core” design, based on the Meyerwerft panel design created within the European Research Project SANDWICH (Advanced Composite Steel Sandwich Structures 2004).

Findings of more recent publications and research are given in the following.

### 3.4.1 High tensile steel

High Tensile Steel (HTS) is generally used in deck and hatch coaming structures areas where large stresses need to be endured. It is used instead of standard mild shipbuilding steel in order to achieve the same strength with lower thickness. However, consequent weight savings are only minor. For instance, considering seagoing vessels, a hull made of 10 % HTS can reduce the steel weight up to around 2 %, while 60 % HTS is expected to result in roughly 10 % of hull weight savings (Radojčić et al. (2021)). According to the same authors, for inland waterway vessels, the total savings would be even less. Moreover, excessive use of HTS and respective scantlings decrease raise problems with respect to fatigue, buckling and corrosion. The usage of HTS for coamings and gangways in order to increase the cargo carrying capacity may result in an elastic behaviour of a vessel with unusually large sagging, e.g. of up to 25 cm as it was the case for the two Serbian self-propelled bulk carriers Sava Mala and Dorcol (Radojčić et al. (2021)).

### 3.4.2 Other material than steel

As alternatives to steel aluminium alloys and composites may be used. They are used for the hull structure when the speed is the most significant design parameter, e.g. in the case of smaller high-speed units. Nevertheless, inland waterway freight vessels may use aluminium alloys and composite materials too. In those cases, the application will be mostly limited to a part of the hull (wheelhouse, superstructure). Important to note is that aluminium solutions are expensive. So far, no significant reduction of the total hull weight has been achieved, using the solutions mentioned in this sub-section.

If other material than steel is used, the equivalent strength has to be proved as in the case of a steel structure. With respect to inland vessels, any lightweight material which is not standard has to be considered on a case by case basis and shall comply with the general rules for materials of the classification societies providing guidance relating to usage of uncommon materials and “not-so-proven” technologies not considered in the fully developed rules.

Regarding material solutions, some other innovations have been developed over the recent years, besides the use of aluminium and composites. Those lightweight materials remain mostly applicable to elements of the superstructure and do not provide a significant reduction of the total weight.

In Binnenschiffahrt (2021), the application of wood, eventually in combination with steel, is mentioned to have realistic chances for implementation as a lightweight solution in inland waterway freight vessels. However, it is also stated that the consideration of lightweight solutions only will be not sufficient for coping with low water events. Measures relating to ship design are also necessary.

### 3.4.3 Sandwich Panel Systems (SPS)

According to Radojčić et al. (2021), SPS seem to be able to replace the traditional steel plate with its secondary stiffeners. A SPS consists of two plates with an elastomer injected in between to form a solid unit (Fig. 33). The scantlings of SPS plating are generally in the range of 3 mm to 8 mm for steel face plates, and 15 mm to 50 mm for core thickness. The new structure is simpler (no secondary members), and hence, it can provide some weight reduction. Based on results of numerous projects carried out in the past, savings of up to 40 % are possible, depending on the vessel under consideration.

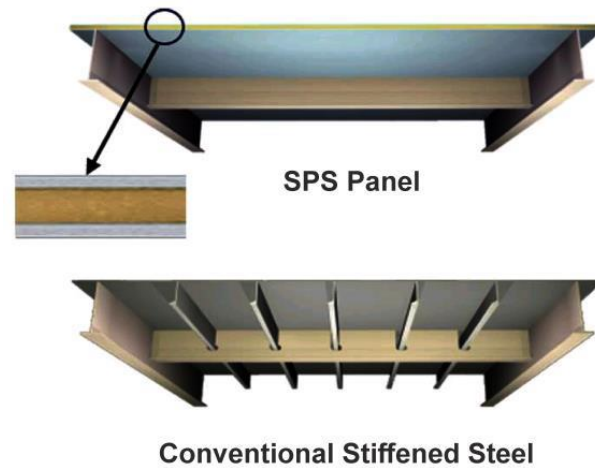

Figure 33: SPS vs. conventional structure. Source: Radojčić et al. (2021), SPS Technology (2020).

With respect to the particular case of a Danube barge (lighter), an innovative SPS barge (lighter) can have a lower weight by only up to 10 % than a conventional (calculated) barge, which is in a similar range as just transferring the structure from a mixed to a longitudinally framed one (see figure below). Consequently, it seems that weight savings should first be examined within the conventional steel construction approach as direct calculations can offer already relevant weight savings, and afterwards through innovative approaches, like SPS.

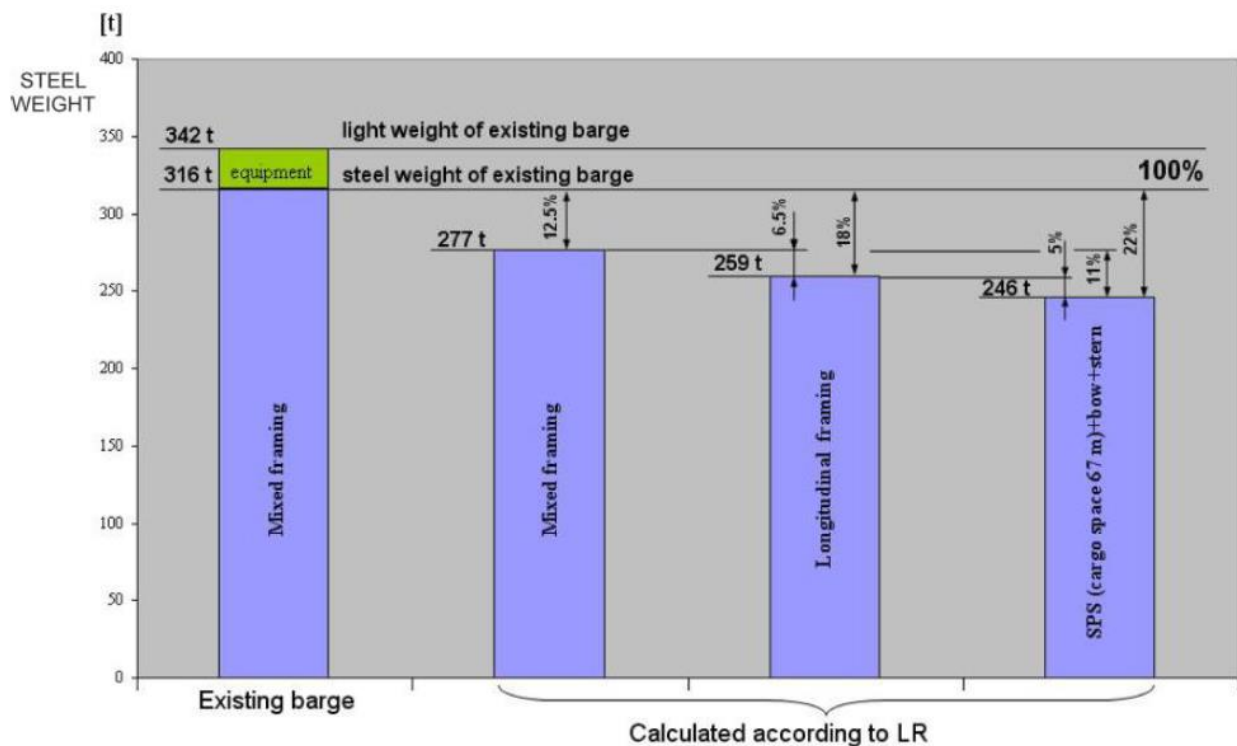

Figure 34: Steel weight comparisons between an existing Danube barge (lighter 77 m x 11 m x 2.8 m) and calculated solutions according to Lloyds Register (LR) comprising mixed and longitudinal framing, as well as SPS. Source: Radojčić et al. (2021).

Nevertheless, in special cases, SPS may have some other advantages, e.g. cheaper production and additional safety. For instance, the inner skin of an inland waterway chemical tanker inner plate could be built of stainless steel and the outer plate of conventional steel, using only 50 % of the expensive stainless steel in current designs.

### 3.4.4 Adhesive Bonding

Welding and riveting are the most common recognized joining technologies in shipbuilding; bolting is used for temporary applications (Radojčić et al. (2021)). Adhesive bonding is a relatively new joining technology in shipbuilding, comprising the usage of adhesives for bonding of different components. The main advantage of this technology is that different materials can be permanently joined together, allowing for wider applications of lightweight structures, e.g. the combination of steel with aluminium alloys or composites. Disadvantages relate to heat and moisture sensitivity and compliance with approval procedures of the classification societies. More can be found in Weitzenböck (2012).

### 3.4.5 Optimisation of framing

In order to achieve a weight reduction, it is not absolutely necessary to use expensive lightweight materials. A weight reduction can be attained also with steel by applying an optimised framing to the ship structure (see Fig. 34), e.g. the structure of longitudinally framed vessels becomes lighter than the ones displaying mixed framing. Further, a change from existing mixed framing solutions to longitudinal framing solutions involving dedicated calculations in accordance with the rules of classification societies may result in substantial weight savings, e.g. 18 % as presented for a Danube barge (lighter) in Fig. 26. However, most of the Danube vessels have an inner bottom thickness greater than prescribed by the rules for the sake of a prolonged life, which explains the discrepancy between the existing and calculated weight of the lighter.

Lighters are usually below 100 m in length and, therefore, mostly mixed or transversely framed. Vessels with lengths over 100 m have to be framed longitudinally due to longitudinal strength issues, reducing the potential for weight savings by optimisation of framing.

### 3.4.6 Optimisation by direct calculations

In accordance with the rules of most classification societies, direct longitudinal strength calculations and consecutive buckling assessments have to be carried out for vessels with a length over 60 m, and in particular if the length to height ratio exceeds 35 (Radojčić et al. (2021)). The rules permit a reduction of hull structure scantlings prescribed by their deterministic formulae if the direct calculations show that the strength of the structure is sufficient. Therefore, a deviation from original standard designs prescribed by the rules of the classification societies becomes possible, and the designer is provided with more freedom in the structural design, allowing for a weight optimisation.

Nowadays, the application of Finite Element Method (FEM) tools is the standard for structural design analyses. Classification societies provide guidelines on how analysis models should be created and what simplifications can be employed for the results to still be reliable, and if necessary, reproduced.

Elomatic describes the basic principle of FEM in the following way: *In the finite element method (FEM), a structure such as a ship hull is divided into small parts (elements), where displacements and strains can be defined with the help of mathematical equations. The equations reveal the stress levels in the elements. Very complex structures can be dimensioned extremely accurately without having to make the broad simplifications or assumptions associated with traditional analytical methods. Modern simulation software programmes and powerful computers are used in simulations. This means that large entities can be modelled and analysed relatively quickly. In addition, changes and different structural solutions can be searched for rapidly. This allows engineers to ensure that the structure fulfils its defined requirements.*<sup>11</sup>

Further information with respect to classification societies and FEM analysis can be found in Radojčić et al. (2021).

<sup>11</sup> <https://blog.elomatic.com/en/modern-methods-in-ship-structure-analysis/#:~:text=In%20the%20finite%20element%20method,stress%20levels%20in%20the%20elements>.

For illustration, Fig. 35 presents the outcome of FEM analysis where the stresses at the hatch coaming and in the mid ship area display high values.

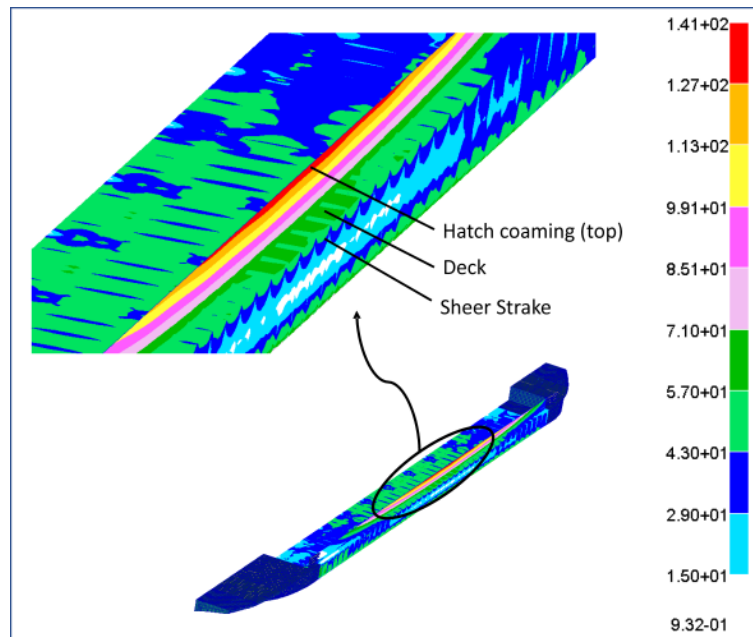

Figure 35: FEM analyses of one unconventional IW vessel: Von Mises stresses in N/mm<sup>2</sup>. Source: Radojčić et al. (2021), Stefanović (2019).

### 3.4.7 Weight reduction potential of some common inland waterway vessels

The ECCONET project (ECCONET (2012)), investigated different measures for reduction of the ship weight:

- high tensile steel instead of mild steel (reduced scantlings and plate thickness);
- reduced frame and/or longitudinal spacing enabling hull construction with thinner plates and
- lighter stiffeners;
- sandwich plate systems or I-Core panels;
- different concept solutions for the midship section in the range of the cargo hold.

The savings in lightweight (ship weight) are presented for typical Rhine vessels in Table 4 and for some Danube vessels in Table 5.

Table 4: Possible weight savings on typical Rhine vessels. Source: ECCONET (2012).

	savings [t]	immersion [t/cm]	More carrying capacity at reduced draught for x[cm] - corresponds to the same drop of water depth and unchanged carrying capacity										Compensation of carrying capacity [t]	
			water level drop [cm]											
			5	6	7	8	9	10	15	20	25	30		
Gustav Koenigs extended	45	6,1	31	37	43	45	45	45	45	45	45	45	45	45
Johann Welker extended	55	7,5	38	45	53	55	55	55	55	55	55	55	55	55
GMS 110	90	11,1	56	67	78	89	90	90	90	90	90	90	90	90
GMS 135	150	14,3	72	86	100	115	129	143	150	150	150	150	150	150
JOWI	200	21,1	105	127	148	169	190	200	200	200	200	200	200	200
Europe II Barge	70	8,0	40	48	56	64	70	70	70	70	70	70	70	70

Table 5: Possible weight savings on typical Danube vessels. Source: ECCONET (2012).

	savings [t]	immersion [t/cm]	More carrying capacity at reduced draught for $x$ [cm] - corresponds to the same drop of water depth and unchanged carrying capacity										Compensation of carrying capacity [t]	
			water level drop [cm]											
			5	6	7	8	9	10	15	20	25	30		
Gustav Koenigs extended	45	6,1	31	37	43	45	45	45	45	45	45	45	45	45
Johann Welker extended	55	7,5	38	45	53	55	55	55	55	55	55	55	55	55
GMS 95	75	10,1	50	60	71	75	75	75	75	75	75	75	75	75
Danube Europe II barge	40	8,0	40	40	40	40	40	40	40	40	40	40	40	40

Both tables show that the application of light weight structures has only a limited effect on the ship weight, in particular, if the ship carries cargo. For the larger vessels (GMS, JOWI), a draught compensation of around 10 cm is obtained. Therefore, the application of lightweight solutions only cannot be considered as sufficient for coping with low water events. However, lightweight solutions can be combined with other measures, e.g. the increase of the breadth, for minimisation of the draught. Lightweight solutions may increase the construction costs, and one has to make a case-by-case decision if the minor reduction of draught is worth this cost increase.

### 3.5. Shallow-water hulls, new buildings

#### 3.5.1. Pusher concept for the Danube

Radojčić (2009) and Radojčić et al. (2021) propose a pusher concept for the Danube with superior shallow-water performance compared to the most common pushers sailing on the Danube (Fig. 36, Table 6).

Table 6: Main characteristics of shallow-water pusher for the Danube compared with the ones of four common pushers on the Danube (Radojčić et al. (2021)).

Pusher		Shallow-water pusher	Brest	Karadjordje	Mercur Series 200	Mercur Series 300
L <sub>OA</sub>	[m]	30.0	37.25	40.45	34.6	34.6
B <sub>OA</sub>	[m]	11.0	11.3	13.00	10.1	11
H	[m]	2.5	2.7	2.8	2.65	2.8
T	[m]	1.4	1.8	1.95/2.15	1.65/1.77	2.04 <sup>12</sup>
Height above basis	[m]	6.0				
P <sub>B</sub>	[kW]	3 x 700	2 x 835	3 x 1280	2 x 900	2 x 1200
Bow thruster	[kW]	250 - 300				
Crew	[-]	8	16	16		

<sup>12</sup> Schweighofer et al. (2018).



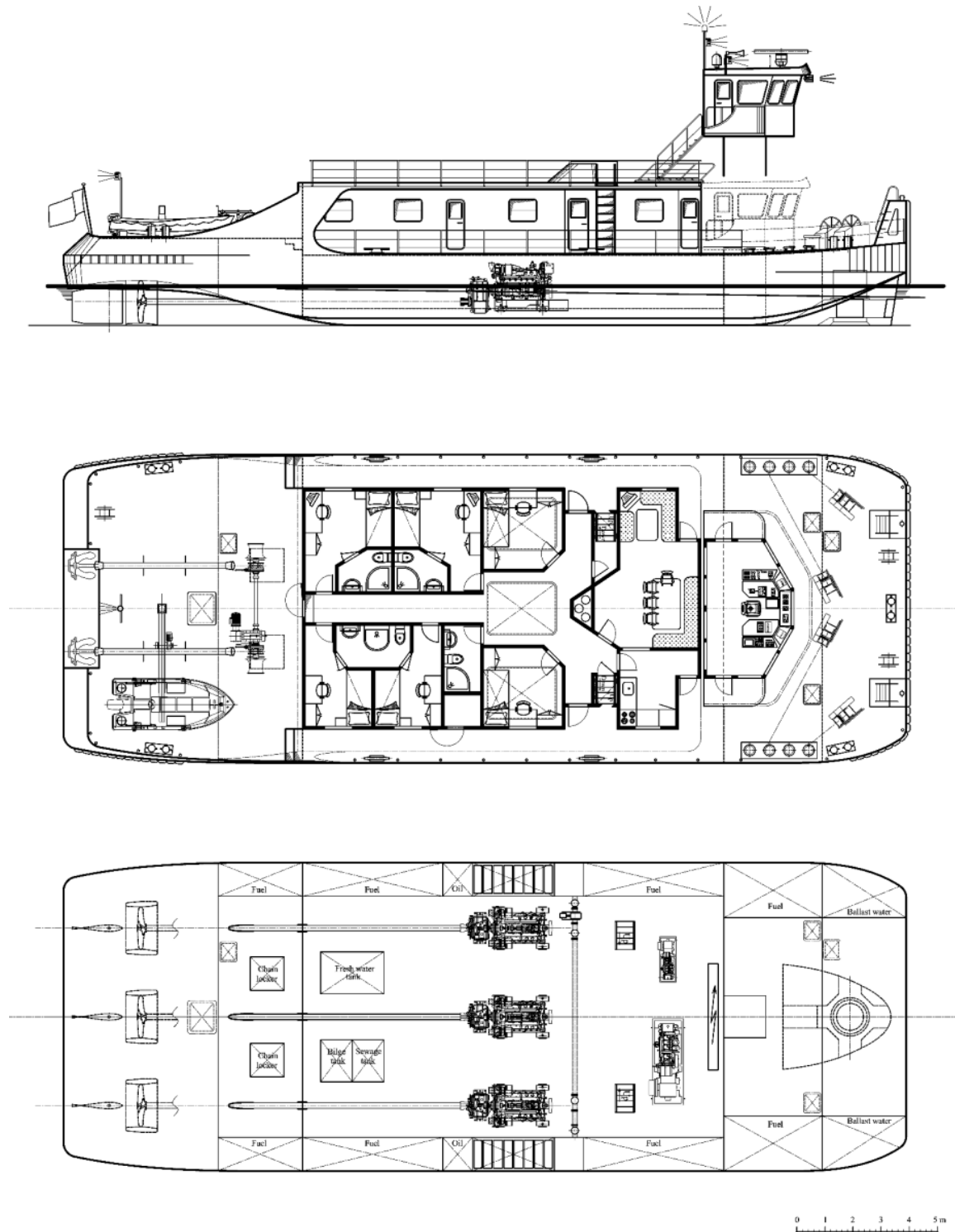

Figure 36: Shallow-water pusher for the Danube. Source: Radojčić et al. (2021).

The main advantage of the proposed pusher is its low draught of only 1.4 m compared with the draught of conventional pushers operating on the Danube ranging between approximately 1.7 m and 2.15 m. Also the power available for pushing a convoy is of a similar magnitude than the one of the conventional vessels due to the distribution of the thrust to three propellers, preventing thereby the occurrence of high propeller loads leading to low efficiencies, possible cavitation, ventilation and loss of thrust. The particular characteristics of the vessel allow for operation of large convoys similar to the ones pushed by the vessels listed, as well as partly loaded lighters can be operated on most stretches of the Danube even at very low water levels equal to LNWL or less, which will not be possible for conventional pushers.

A gondola-type bow thruster of 250 ÷ 300 kW enables enhanced manoeuvring capabilities, eliminating the necessity for conventional flanking rudders and improving stopping abilities. Due to the absence of flanking rudders, unobstructed water inflow to the nozzles can be achieved resulting in a higher efficiency. This feature is very important particularly for highly loaded propellers, e.g. due to limited propeller diameter being a result of the draught limitation.

Taking into account the benefits of the application of the latest technological achievements increasing efficiency, safety, environmental performance and comfort, a new pusher design will be most probably superior to a conventional elder design created according to the standards 30 or more years ago.

With respect to the design of a shallow-water pusher to be operated on the Danube, Radojčić et al. (2021) give a set of recommendations. Selected examples of relevance to coping with shallow water including minor amendments are presented in the following:

- Draught equal to 1.4 m at the maximum, still allowing for the installation of a propeller in a nozzle with a diameter of 1.5 m which can accept the power of up to 700 kW. This makes a three-propeller installation feasible. A standard Danube barge with a draught of 1.5 m can be operated carrying a bit less than 800 t, which is approximately half of the carrying capacity of a fully loaded lighter at 2.5 m.
- Triple-screw propulsion, (skewed) propellers in nozzles with a diameter of 1.5 m, should be located in a relatively shallow tunnel. A somewhat larger propeller diameter would be allowable (and desirable), but taking into account the limited breadth of 11 m and high-speed diesel engines, it is believed that 1.5 m would be just sufficient. With an engine power of 700 kW, the propeller loading would be 375 kW/m<sup>2</sup>, which is high, but still acceptable. Special attention should be paid to the design of the tunnels, propellers and nozzles with the aim to increase the thrust and to reduce the vibrations by using model tests and CFD.
- Breadth equal to 11 m, which is the same as the one of a standard Danube lighter. A little larger breadth can be chosen too, as the pusher is usually pushing a much wider convoy. Even if only one lighter is pushed, a pusher being little wider than the lighter will not cause a noticeable increase of the power requirement. Lighter packing, however, is easier if both the pusher and the lighter have the same width. Nevertheless, if the draught is limited, then either the length or width (or both) should substitute the needed buoyancy. Consequently, the best choice seems to be to set the breadth to 11 m. An additional advantage of setting the breadth to 11 m is the improved flexibility of the vessel with respect to the operational area, e.g. it will be able to enter all locks with widths ranging between 12 m (e.g. Main- Danube Canal), 24 m (e.g. Austria, Slovakia) up to 34 m (Iron Gates 1, 2). The vessel allows also for efficient use of locks as additional standard vessels with a maximum width of e.g. 11.4 m can be placed alongside the convoy arranged in longitudinal formation, increasing thereby the amount of vessels to be locked within one lock operation.
- Length equal to around 30 m, under the condition that there is enough space for all necessary machinery and crew. A little longer vessel (if the breadth and the draught are fixed) can be accepted. With a length equal to 30 m, the overall length of a convoy of two lighters and a pusher will become  $2 \times 77 + 30 = 184$  m, which is still sufficient for passing through the Danube locks.
- Height equal to 2.5 m is considered to be a minimum in order to allow for a proper arrangement of the engines and other necessary machine-room equipment below the deck.
- The weight (dry) is estimated to be 270 t taking into account lightweight engines and other equipment and machinery. A larger value might compromise the draught and therefore the project itself. A fully loaded pusher with fuel and other provisions should weigh around 350 t (at a draught of 1.4 m). Weight saving should be considered wherever possible (SPS technology might be employed for the superstructure).
- The ship form and in particular the tunnels are of utmost importance as a relatively large power has to be installed within an extremely shallow draught hull. The transom and propellers should always have a draught of around 1.4 m, while weight variations (due to fuel consumption) should change the bow draught only. Model tests and CFD analysis are recommended.

- Propulsion: low emission Stage V diesel engines: 3 × 700 kW with high power to weight ratio. The installed power of around 2000 kW is expected to be sufficient for operating a convoy of six lighters at a draught of 2.5 m (1500 – 1600 t cargo carried by each lighter) and usual convoy speeds.
- Steering: three fish-tail rudders located behind propellers (without flanking rudders) and a gondola type bow thruster, with electrical motor of around 300 kW, should be considered.
- Wheelhouse: it shall have the ability to be raised for increasing the visibility for compliance with the statutory regulations in force.
- Finally, modern lightweight equipment and materials should be considered wherever possible, as larger weight than predicted can easily compromise the performance of every pusher, resulting in a greater draught as planned.

### 3.5.2. Wide-body self-propelled X-type vessel for the Danube

Within the IDV project (IDV 2014), several innovative ship concepts for operation on the Danube were investigated. For a large motor cargo vessel, the optimal main characteristics were defined as  $L = 105$  m,  $B = 11.40$  m and  $T = 2.8$  m (see Table 7). Within the project, a parameter variation of the main characteristics of a motor cargo vessel was performed, aiming at a concept being able to sail at very low water levels. A shallow-water concept was further developed, including detailed strength considerations. As result, the so-called E- type vessel was derived (Bačkalov et al. (2014)). The main characteristics of the vessel are  $L = 103.75$  m,  $B = 15$  m,  $T = 2$  m and  $H = 2.15$  m. Apart from the challenges with respect to structural strength resulting from the great L/H ratio, its operational area will be limited due to the size of the locks (e.g. Main-Danube Canal with a lock width equal to 12 m, see also section above), and it prevents also efficient lock operations as no other standard vessel can be placed aside it in a lock. On the other hand, there are already vessels with similar breadth in operation on the Danube (see Table 7). Based on this vessel, further developments were carried out, resulting in an optimised shallow-water container vessel: the so-called X-type vessel (Figs. 37 and 38, Bačkalov et al. (2016)).

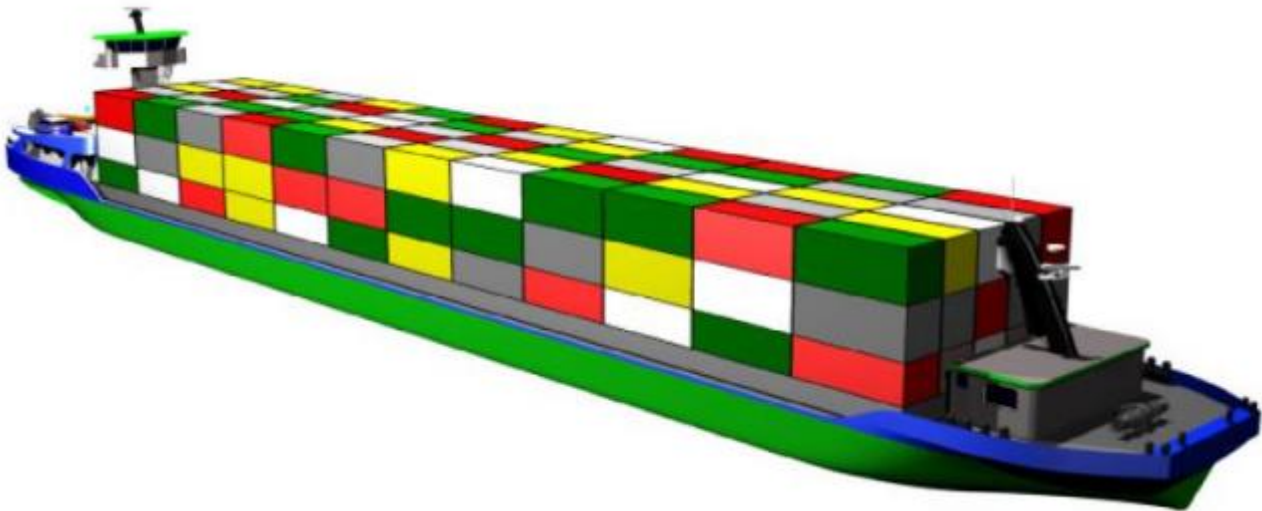

Figure 37: Wide-body self-propelled X-type vessel for the Danube. Source: Radojčić et al. (2021), Bačkalov et al. (2016).

The main features are presented in Table 7. The vessel was optimised for maximum amount of containers and prolonged navigation during a year (transport of four container layers at normal water conditions and three container layers at low-water conditions). The breadth is result of the requirement that 5 containers shall placed abreast. The freeboard is just a little above the minimum value demanded by the rules ( $= 0.2$  m). The propulsion system is conceived to be diesel powered with twin ducted propellers (propeller diameter = 1.55 m).

The vessel does not satisfy the  $L/H < 35$  condition. Therefore, also in this case, dedicated calculations of the structural strength were carried out in compliance with the rules of DNV-GL (GL (2011)). Those calculations showed

that, although the vessel was partially strengthened, its lightweight mass (and hence, the deadweight) is still comparable with the one of “standard” designs (see also Table 7).

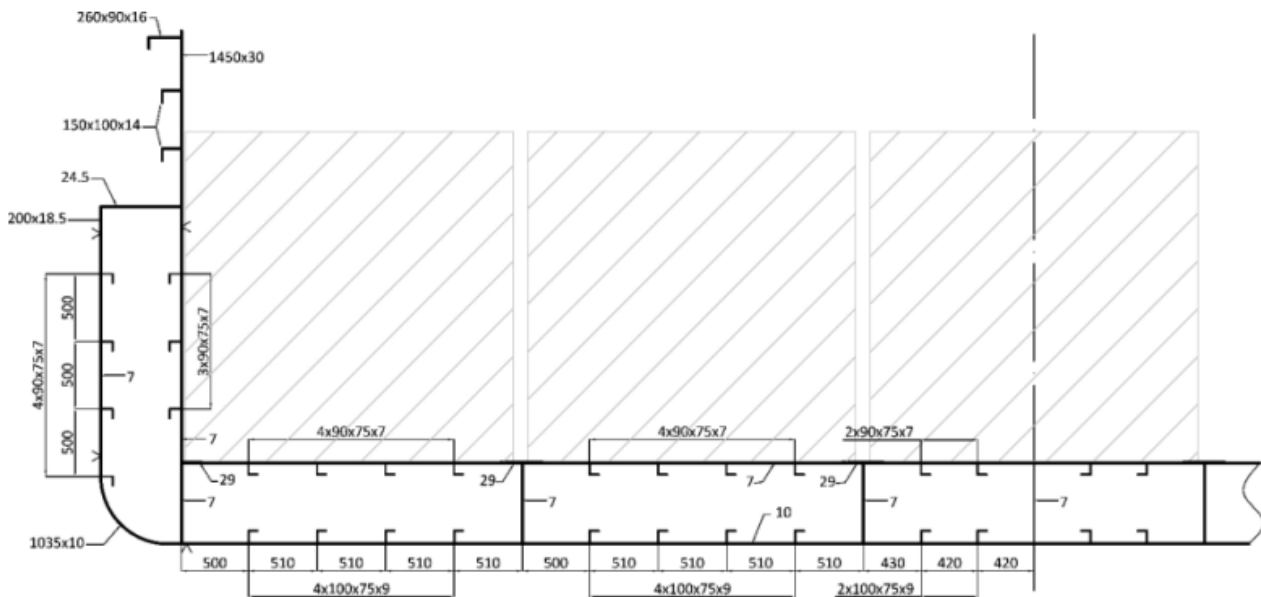

Figure 38: Wide-body self-propelled X-type vessel for the Danube: gross scantlings of the mid body cross section. Source: Radojčić et al. (2021), Bačkalov et al. (2016).

Table 7: Main characteristics of different vessels concepts and vessels in operation on the Danube. Source: IDV (2014), Radojčić (2009), Bačkalov et al. (2016), Prominent (2015).

		IDV (2014) GMS class V	Radojčić (2009)	X-Type	DNL 2000 (SPAP)	MNL 1500 (SPAP)
L	[m]	105	104	103.8	101.8	106
B	[m]	11.40	11.65	13.90	14.18	11.20
T	[m]	2.80	2.50	2.30	2.40	2.40
H	[m]		3.10	2.50	3.60	3.20
TEU	[-]		208	240		
m <sub>DWT</sub>	[t]	2350	1970	2248	2000	1500
m <sub>LWT</sub>	[t]	670	696	671		
P <sub>B</sub>	[kW]	800 kW	4 x 400		1030	1030

In Table 7, the main characteristics of different vessels developed and in operation are compared. These are an optimised motor cargo vessel developed in the IDV project (MGS class V, IDV 2014)), a shallow-water container vessel developed by Radojčić (2009), the X-type vessel developed by Bačkalov et al. (2016) and two existing vessels with low draught operated by the Slovakian shipping company SPAP (Prominent (2015)). The comparison shows that, with respect to cargo carrying capacity, the X-type vessel is superior to the optimised standard vessel as it can be operated more days during a year and it is able to carry more cargo at lower water levels, while it performs similarly than the standard vessel (GMS class V) at normal water conditions. It is also superior to similar vessels in operation designed also for relatively low water depths (DNL 2000, MNL 1500) due to its ability to carry significantly more cargo. The comparison with DNL 2000 shows also that the greater width is not necessarily an obstacle for operation on the Danube as the DNL 2000 displays even a greater depth. In addition, the comparison with DNL 2000 shows that the construction of the X-type vessel can be regarded as feasible from a technical point of view as

its main dimensions do not deviate dramatically from the ones of the DNL 2000, and issues relating to sufficient strength can be overcome as the calculations performed show.

### 3.5.3. NOVIMAR Class Va container ro-ro vessel, shallow draught

In the Horizon 2020 EU project NOVIMAR<sup>13</sup>, two shallow-draught versions of the NOVIMAR Class Va container ro-ro vessel have been designed with the purpose to enable navigation in shallow waters such as parts of the river Danube (Fig. 39, NOVIMAR (2020)<sup>14</sup>):

- cargo access over a stern ramp with a retractable wheelhouse placed forward (“stern access version” concept);
- wheelhouse positioned at L/2 elevated above the cargo, with cargo access both over the stern and over the bow allowing drive-through possibilities or double-end loading (“double-end access version” concept).

The objective of the vessels is to enable efficient ro-ro service also where the water depth is limited like in parts of the Danube river and occasionally in the Rhine river due to seasonal changes which is expected to be emphasized due to the climate change. The shallow draught design comes unavoidably with a number of draw-backs. With no cargo below the main deck, the space utilisation and cargo space capacity are reduced as well as the stability due to a higher centre of gravity. However, the concepts have the potential to provide attractive waterborne services, where available water depth is a significant limitation.

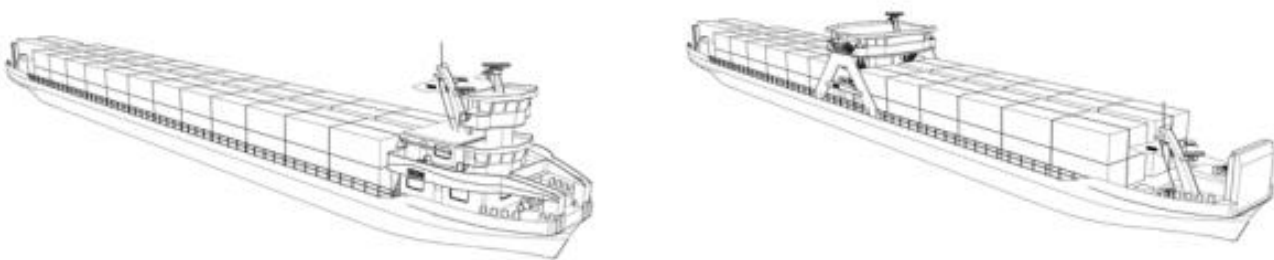

Figure 39: NOVIMAR Class Va container ro-ro vessel, shallow draft designs: “stern access” concept (left), “double-end access” concept (right). Source: NOVIMAR 2(020).

The main dimensions of the vessel concepts developed are:

	Stern access version	Double-end access version
• Length over all:	104 m	104 m
• Width:	11,45 m	11,45 m
• Draft, design	2 m	2 m
• Depth	3 m	3 m
• Air draft	6,5 m	8,9 m
• Cargo capacity	104 TEU a' 11.3 ton or 26 trailers	100 TEU a' 11.8 ton or 24 trailers
• Displacement	2097 ton	2097 ton
• Light ship weight	780 ton	799 ton
• Design speed	18 km/h 9,7 knots	18 km/h 9,7 knots

<sup>13</sup> <https://novimar.eu/>

<sup>14</sup> <https://novimar.eu/handbook/vessel-and-cargo-systems/>

Also these concepts were in detail investigated and calculated, as well as comprehensive engineering documentation is available in NOVIMAR (2020).

### 3.6. Creation of additional buoyancy

#### 3.6.1. Side blisters

ECCONET (2012) investigated the application of side blisters inland waterway vessels. The basic idea is based on additional buoyancy which can be created when needed for coping with low water. Under favourable conditions, close to those for which the ship is actually optimised, the blisters would be put away and the ship would continue the service with optimal performance. In Fig. 40, the basic principle is illustrated. Table 8 features the payload gained for different vessel types.

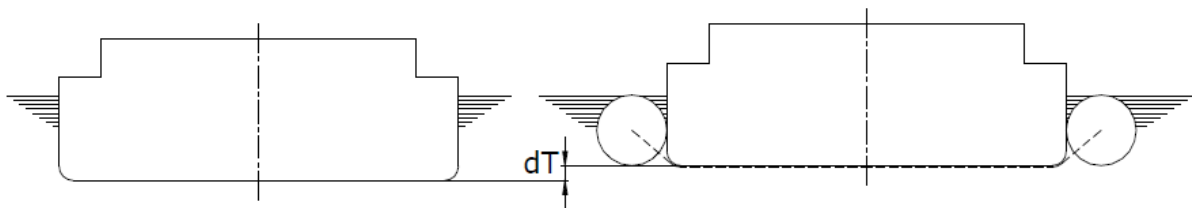

Figure 40: Inland vessel without and with side blisters. Source: ECCONET (2012).

Side blisters with the following dimensions were undertaken a closer look in ECCONET (2012):

- cylinder length – 55 m;
- diameter –  $\Phi 2$  m;
- material – steel;
- total weight of two cylinders including equipment – 80 t.

The impact on the payload gained through draught savings caused by the application of the side blisters is shown for different common ship types in the table below.

Table 8: Payload gained through the application of side blisters to different common inland waterway vessels. Source: ECCONET (2012).

T	Payload gained through draught savings			
	G.Koenigs-e	J.Welker-e	GMS-95	GMS-110
[m]	[t]	[t]	[t]	[t]
1,10	115			
1,20	136	136		
1,30	158	158		
1,35	168	168	168	168
1,40	178	178	178	178
1,50	198	198	198	198
1,60	216	216	216	216
1,70	233	233	233	233
1,80	248	248	248	248
1,90	259	259	259	259
2,00	266	266	266	266
2,10	266	266	266	266
2,20	266	266	266	266
2,30	266	266	266	266
2,40	266	266	266	266
2,50	266	266	266	266

Besides cylindrical steel blisters, there is a series of other technical solutions based on the same principle of providing additional buoyancy during low water periods and switching this feature off during favourable nautical conditions, thus enabling the vessel to achieve its optimal hydrodynamic performance. These could be for instance inflatable blisters carried onboard as a permanent part of the ship's equipment and blow them up and off upon need (Fig. 41, Ramne et al. (2020)), as well as steel made blisters of a shape other than cylindrical in order to mitigate resistance through the water.

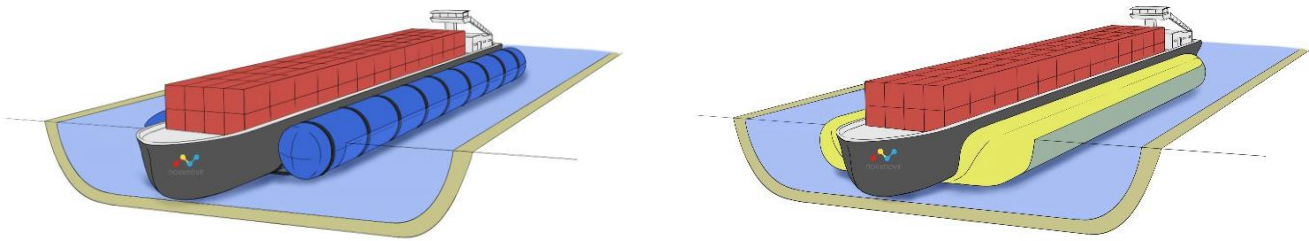

Figure 41: Modular coupling concept used to connect temporary air pads (left). Membrane air pad concept: schematic view with vessel (right). Source: Ramne et al. (2020).

### 3.6.2. Foldable buoyancy elements

According to ECCONET (2012), a very interesting idea is also the application of foldable buoyancy elements integrated into the ship's body which can be laterally extracted (see next page, Figs. 42 and 43). The vessel is being lifted to its necessary draught due to pressurised air filled into the extracted elements. Thus, this vessel is able to economically operate both in high and low water depth carrying the same cargo volume. Table 9 features the payload gained for different vessel types.

The necessary power supply, hydraulic, pneumatic and electric equipment, fittings and piping are almost independent of the ship size between the G. Koenigs and the GMS-110, while the costs for the production and the installation of the foldable steel structure depend mostly on the length of the ship.

At present, practical experiences of side blisters in use, be it cylindrical or laterally foldable solutions are not known yet. It is however expected, that such systems - besides possible handling and lock-passing problems – might be rather sensitive against damaging. Very little is known about the behaviour of large inflated bodies and all interactions related to this, being amongst others vessel resistance, stability and manoeuvrability. More details on further concepts under development can be found in Ramne et al. (2020).

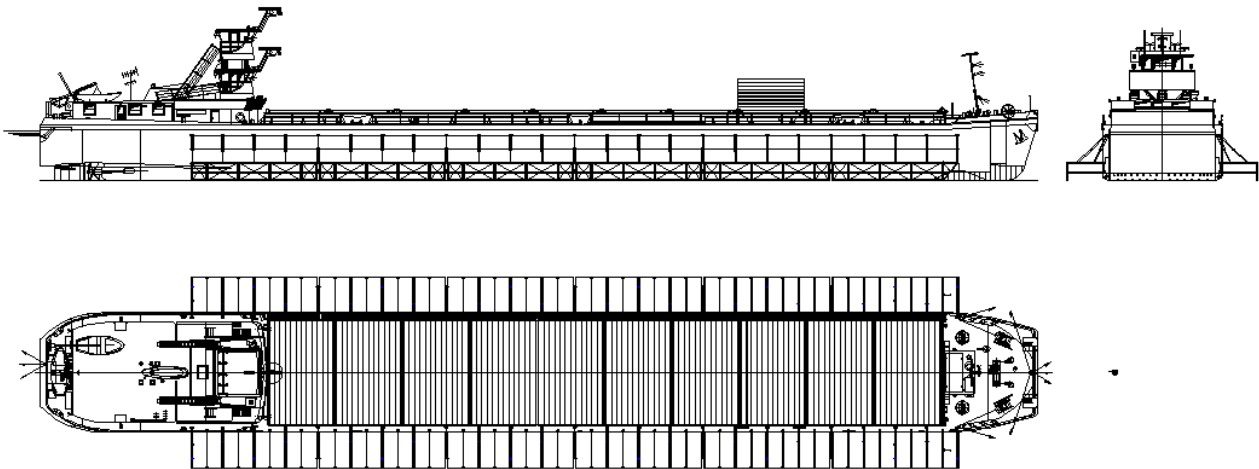

Figure 42: General arrangement of an inland waterway vessel with foldable buoyancy elements. Source: ECCONET (2012).

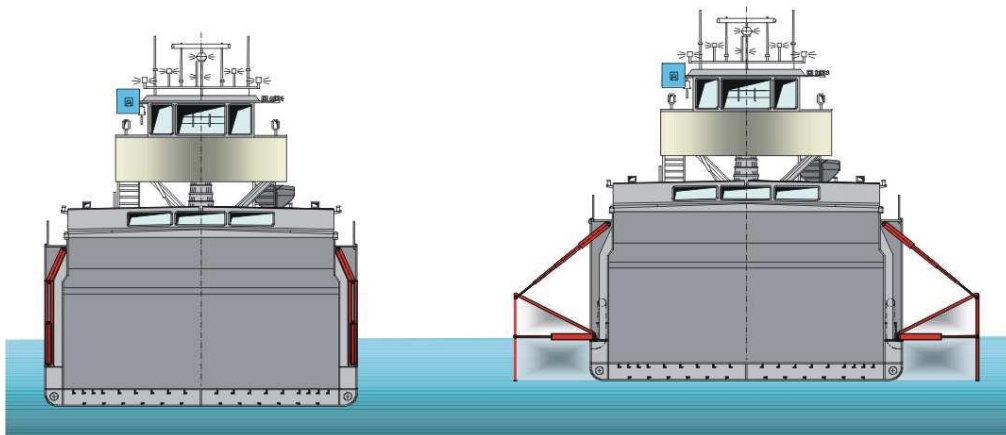

Figure 43: Cross section of an inland waterway vessel with foldable buoyancy elements. Source: ECCONET (2012).

Table 9: Payload gained through the application of foldable buoyancy elements to different common inland waterway vessels. Source: ECCONET (2012).

Payload gained through draught savings				
T	G.Koenigs-e	J.Welker-e	GMS-95	GMS-110
[m]	[t]	[t]	[t]	[t]
1,10	138			
1,20	156	203		
1,30	175	226		
1,35	184	237	333	386
1,40	193	249	349	404
1,50	212	271	379	439
1,60	230	294	409	474
1,70	248	316	440	509
1,80	267	339	470	544



### 3.6.3. Dock ship

A dock ship is a floating construction capable of taking a vessel onboard at a reduced final draught of the transportation system. The conceptual design of a dock ship is oriented towards a selected bottleneck, e.g. a distinct shallow water area. At stationary bottlenecks, it may be beneficial to offer additional buoyancy as a service by a dock ship. In this way, integration of additional buoyancy into each individual vessel is spared. To pass short sections of the fairway with insufficient water depth, two different attempts are conceivable to help loaded vessels; on the one hand a powered dock ship and on the other hand a similar module without own propulsion system (Ramne et al. (2020)).

In Fig. 44, a sketch as well as a concrete concept design of a dock ship including propulsion and steering units with pronounced propeller tunnels are presented.

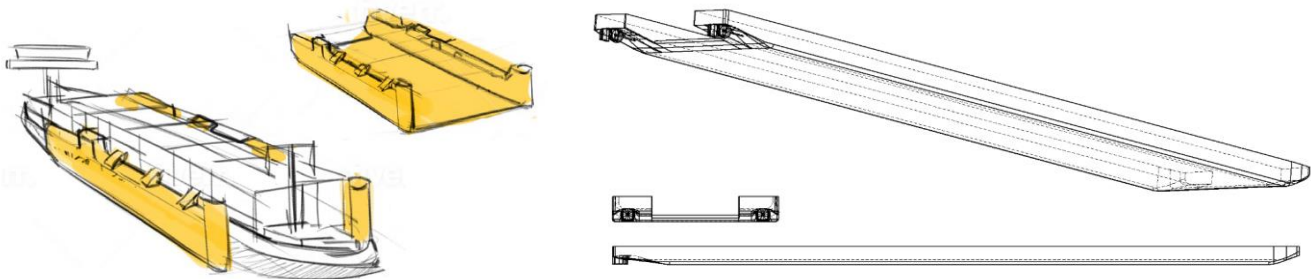

Figure 44: Design sketch of a simple dock ship structure which can be used modularly (left). Model of the concept design of a dock ship including propulsion and steering units with pronounced propeller tunnels developed in the H2020 EU project Novimove. Source: Ramne et al. (2020).

The possible draught reduction is depending on the length of the dock ship amongst others. E.g. for a dock ship length of 135 m, the draught can be reduced from 1.85 m to 1.4 m (=  $T_{\text{docked}}$ ) or 2.29 m to 1.6 m (=  $T_{\text{docked}}$ ), see Table 10.

Table 10: Draught reduction in relation to length. Source: Ramne et al. (2020).

Dock ship length [m]	115	125	135
Draught reduction [cm] for $T_{\text{docked}}$ (1.4 m)	22	33	45
Draught reduction [cm] for $T_{\text{docked}}$ (1.6 m)	42	54	69

Whether a solution with air pads or pipes and belts would fit multiple ships and serve as “buoyancy as a service” option has to be investigated in more detail. Another important factor for the viability of the concepts is the propulsion. In the meantime, the work in NOVIMOVE (see also Chapter 4) has shown that the thrust of the ships is sufficient to sail with added buoyancy due to the low power demand at attainable speed in extremely shallow water.

## 3.7. Stakeholder interviews

In Scholten and Rothstein (2012), a very comprehensive set of outcomes of interviews with shipowners relating to impacts of low water on inland waterway transport is presented. The interviews were carried out in the framework of the KLIWAS programme<sup>15</sup>. 417 persons took part in the interview. However, only 55 interviews were complete for further analysis. With respect to the feasibility of the implementation of adaptation measures proposed in the questionnaire, the following results were obtained in the order of their feasibility (in brackets percentage of agreement):

<sup>15</sup> [https://www.kliwas.de/KLIWAS/EN/Home/homepage\\_node.html](https://www.kliwas.de/KLIWAS/EN/Home/homepage_node.html)

1. usage of new, lighter materials in shipbuilding (61 %);
2. better adaptation of cargo to be transported to available water depth (60 %);  
24-hours operation of vessels (60 %);
3. construction of vessels with improved manoeuvrability (59 %);
4. operation/construction of smaller vessels (57 %);
5. keeping available additional vessel capacities, in particular comprising smaller vessels (52 %);  
improvement of hull form (stern, 52 %);
6. usage of more pushed convoys (43 %);
7. combined transport of containers and bulk cargo (41 %);
8. more propulsion units (at the shoulders, 27 %);
9. semi-catamarans (17 %);
10. buoyancy elements on ship sides (13 %);
11. paddle-wheel like solutions at the stern (10 %);

It can be seen that the most feasible measures relate to the application of lighter materials and usage of smaller vessels. The usage of buoyancy elements on ship sides was ranked quite low. At that time only preliminary theoretical concepts were available. Meanwhile very comprehensive development work has been carried out in the Horizon 2020 EU project Novimove<sup>16</sup>, which might have an impact on the ranking above. See also Chapter 4.

Further adaptation measures relating to ship technology were mentioned by the ship owners comprising:

- construction of vessels with reduced weight, less heavy double-hull tankers;
- operation of smaller vessels;
- too much ship capacity is existing; vessels of the years 50 up to 70 shall be scrapped, usage of vessels constructed 85 up to now;
- equipment of more vessels in order to become capable of pushing and being pushed;
- reconstruction of tow-barges;
- improvement cargo-carrying capacity: full hull form, improved hydrodynamics, low-weight construction materials, sufficient stability;
- economic limitation of ship speed to 7 km/h; electronic steering of vessel, reducing personnel and improving safety; look into the past for working developments;
- optimisation of propeller size => smaller propellers; lightweight construction as practiced in the 80ies; usage of vessels constructed between 1960 and 1985, they are low-water resistant.

Proposed supportive measures relating to ship technology to be taken on the ministry level and by the Federal Waterways and Shipping Administration (WSV):

- persuade banks of financing of smaller units;
- limit ship sizes such way that the vessels will be able to sail at least 250 days a year on the waterways they have obtained their permits for;
- set draught of vessels, instead of free choice of draught resulting in insufficient safety clearance between vessel and river bottom;
- no new super vessels (150 m); scrapping of older vessels; get back to ship sizes of the past; adaption of the vessel – not the fairway;
- renewal of crew regulations.

With respect to measures to be taken on the Rhine, only one ship-technology relevant one was mentioned:

- no certificate for very large vessels in order avoid danger to other vessels.

<sup>16</sup> <https://novimove.eu/>

## 4. Recent developments

### 4.1. FlaBi

The overall objective of the joint project “FlaBi” is to increase the resilience of inland vessels during pronounced periods of drought by extending their operational limits. To achieve this goal, three project partners are developing innovative ship designs with suitable propulsion systems in combination with lightweight structures. The new concepts will be concretised for the requirements of the Rhine and Elbe river at extreme low water levels. In addition, a retrofit concept for propulsion and steering devices will be developed for the existing fleet, which will improve suitability for extreme low-water conditions.

The propeller manufacturer J.M. Voith SE & Co. KG and the University of Duisburg-Essen are project partners. Major shipping companies in inland navigation, the associations BDB, VBW and the shipyard SET Tangermünde support the project as associated partners.

In the sub-project “FlaBiTec”, DST is investigating three different propulsion concepts, a 2<sup>nd</sup> generation blade-chain drive, a modified paddle wheel drive and the conventional ducted propeller with regard to their operational limits. The appropriate integration of the propulsors into the ship’s hull represents a major challenge. In addition to different propulsors, design measures to reduce the lightweight are also being investigated. The technical developments will be suitably combined in dedicated ship designs. Subsequent model tests serve to identify the operational limits of the designed ships and enable a comparison with existing ships.

To achieve these goals, DST has prepared a comprehensive analysis of the boundary conditions with a focus on the Rhine. The water levels, the existing fleet and further parameters were examined in order to identify the latest requirements for new ships. Based on this, hulls were designed and adapted to the respective propulsion concept which will be followed by model tests to identify the limits for each system and to examine how different systems perform in comparison to each other. A further goal is the extension of numerical methods to enable a better prediction of the operational limits under extreme conditions at an early design stage. Furthermore, the propulsion concepts, an optimised main frame, as well as a ship geometry will be developed with a special focus on lightweight constructions.

The Federal Ministry for Economic Affairs and Climate Action of Germany is funding the project as part of the “Maritime Research Programme” under the funding reference 03SX532A.

Duration: December 2020 – November 2023

Contact: Dipl.-Ing. Jens Ley, [ley@dst-org.de](mailto:ley@dst-org.de), Tel.: +49 (0)203 99369-30

<https://www.dst-org.de/verbundvorhaben-flabi-gestartet/>

### 4.2. DüPro

Building on the previous research project "Determination of the effective propeller inflow for inland navigation" (BMDV project number: 97.357/2015), an extensive matrix of model tests and CFD simulations was planned, carried out and analysed in the period from November 2018 to May 2022 at DST. In addition to the systematic investigations of the ducted propellers alone in open-water configuration, the focus was particularly on the interaction with various aft ship concepts. Motivated by the low water period in autumn 2018, very small water depths and corresponding draughts up to thrust loss due to ventilating propellers were also considered.

In the propeller inflow project, four different ship designs with the dimensions of the Large Rhine Vessel (110 m × 11.44 m) have been investigated on a scale of 1:16. This model family consisting of two single-screw (propeller diameter 1.76 m) and two twin-screw (propeller diameter 1.60 m) ships has now been extended by two additional

designs. These are a design with a flex tunnel and a design with rudder propellers. In view of the low-water event, both were designed with a smaller propeller diameter of 1.40 m. In order to avoid too small model propellers and to increase the accuracy of the investigations, the new designs and additionally a single screw and a twin-screw vessel from the previous project were now built in the larger scale 1:11, i.e. with 10 m model length.

New model propellers with geometry and nozzles provided by Promarin - Propeller- und Marinetechnik GmbH were made for all models. This set of six rear ships, eleven propellers and 20 nozzles, some with additional variants, was tested in about 160 experiments with up to 20 measurements each. The parameters and results of the tests in open-water as well as in the self-propulsion tests are presented alongside the extensive CFD simulation results in a final report of around 350 pages.

While complex conditions and circumstances, such as propulsion with ventilation or extreme shallow water conditions, can be better investigated experimentally, validated CFD methods provide insight into hydrodynamic details and systematic comparisons. Shipyards, engineering offices and companies in the supply industry can use the results for improved ship design or in the context of the German state aid scheme "Sustainable Modernisation". There is also great potential for optimisation in the optimised design of hull and propulsor for real operating conditions in the context of an aft-ship replacement.

The large differences in the power demand of different ship concepts under shallow water conditions illustrate the potential of an EEDI/EEOI approach adapted to inland shipping. Large differences are also evident in the limits of propulsion of the various aft ship forms. Further investigations are needed, including safe manoeuvring and stopping.

The project received funding from the Federal Ministry for Digital and Transport of Germany.

Duration: November 2018 – May 2022

Contact: Dipl.-Ing. Benjamin Friedhoff, [friedhoff@dst-org.de](mailto:friedhoff@dst-org.de), Tel.: +49 (0)203 99369-29

<https://www.dst-org.de/en/duepro-systematic-investigation-of-ducted-propellers-for-inland-navigation/>

### 4.3. NOVIMOVE - Novel inland waterway transport concepts for moving freight effectively

Inland Waterborne Transport (IWT) advantages as low-energy and low CO<sub>2</sub> emitting transport mode are not fully exploited today due to gaps in the logistics system. Inland container vessels pay six to eight calls at seaport terminals with long waiting times. More time is lost by sub-optimal navigation on rivers and waiting at bridges and locks. In addition, low load factors of containers and vessels impact the logistics systems with unnecessary high numbers of containers being transported and trips being made. The NOVIMOVE strategy is to "condense" the logistics system by improving container load factors and by reducing waiting times in seaports, by improved river voyage planning and execution, and by facilitating smooth passages through bridges and locks. NOVIMOVE's innovations are:

- cargo reconstruction to raise container load factors;
- mobile terminals feeding inland barges;
- smart river navigation by merging satellite (Galileo) and real time river water depths data;
- smooth passage through bridges/locks by dynamic scheduling system for better corridor management along the TEN-T Rhine-Alpine (R-A) route;
- concepts for innovative vessels that can adapt to low water condition while maintaining a full payload;
- and close cooperation with logistic stakeholders, ports and water authorities along the R-A route: Antwerp, Rotterdam, Duisburg, Basel.

NOVIMOVE technology developments will be demonstrated by virtual simulation, scaled model tests and full-scale demonstrations. NOVIMOVE innovations will impact the quantity of freight moved by IWT along the R-A corridor by 30 % with respect to 2010 baseline data. The NOVIMOVE 21-members consortium combines logistics operators, ports, system-developers and research organisations from 4 EU member states and two associate countries. The work plan contains 4 technical Work Packages. The project duration is four years; the requested funding is 8.9 million EUR.

While previous projects like FP7-ECCONET – Effects of climate change on the inland waterway transport network (ECCONET (2012)) already considered approaches like so-called steel side blisters, inflatable blisters and foldable buoyancy elements as theoretical concepts (see also Chapter 3), NOVIMOVE has the ambition to bring the added-buoyancy concepts to a higher TRL. The corresponding work includes iterative detailing of hydrodynamic characteristics, regulatory and operational aspects, related investment costs (CAPEX) and operating cost (OPEX) as well as structural design.

Just recently, with respect to solutions for coping with low-water events two reports, initially classified confidential, were made public:

Friedhoff, B. et al. (2020). Detailed requirements for innovative vessel and cargo handling concepts - D4.1. Technical report of the H2020 EU project Novimove.

Ramne, B. et al. (2020). D4.2 - Concepts and selection of innovative NOVIMOVE concepts. Technical report of the H2020 EU project Novimove.

Duration: June 2020 – May 2024

Project coordinator: Prof. Dr. R.R. Negenborn, TU Delft, the Netherlands, [r.r.negenborn@tudelft.nl](mailto:r.r.negenborn@tudelft.nl)

[www.novimove.eu](http://www.novimove.eu)

<https://cordis.europa.eu/project/id/858508>

#### **4.4. Shallow-water tanker of BASF**

Following the experience with the low water levels of the Rhine in 2018 when a suitable ship and sufficient alternative transport capacity was not available and based on own assessment that such events may occur more frequently in the future, BASF has taken several measures at the Ludwigshafen site to increase the security of supply for production. An important element of the considerations conducted was to order a ship that can still reliably transport substantial quantities even at the lowest Rhine levels (Fig. 45, (BASF (2021))).



Figure 45: Shallow-water tanker of BASF. Source: BASF<sup>17</sup>.



Van der Velden® Three-rudder system

Van der Velden® FLEX Tunnel

Figure 46: Van der Velden® Three-rudder system (left) and Van der Velden® FLEX Tunnel of the BASF tanker. Source: Damen<sup>18</sup>.

The new tanker will be one of the largest tankers on the Rhine, and it will be particularly useful when the Rhine is at low water. It will still be able to pass the critical point in the Rhine near Kaub with a cargo of 650 t even at a water level of 30 cm (corresponds to a water depth of 1.60 m and a ship draught of 1.2 m), which is significantly more than any other tanker available today can carry. At average low-water level, its transport capacity of around 2500 t will be twice of the one of a conventional inland vessel. The tanker is expected to enter operation end of 2022<sup>19</sup>.

<sup>17</sup><https://dispersions-resins.basf.com/emea/en/news-ticker/basf-presents-innovative-tanker-for-low-water-on-the-rhine.html>

<sup>18</sup>[https://archive.damen.com/en/news/2021/05/dmc\\_flex\\_tunnels\\_three\\_nozzles\\_and\\_three\\_manoeuvring\\_systems\\_for\\_new\\_tanker\\_for\\_stolt\\_and\\_basf](https://archive.damen.com/en/news/2021/05/dmc_flex_tunnels_three_nozzles_and_three_manoeuvring_systems_for_new_tanker_for_stolt_and_basf)

<sup>19</sup><https://www.weka.de/einkauf-logistik/basf-baut-ihre-niedrigwasserflotte-aus/>

The vessel (Fig. 45) features the following characteristics (Blank (2022), BASF (2021)):

- increased main dimensions: L = 135 m, B = 17.5 m instead of L = 110 m, B = 11.4 m;
- improved cargo carrying capacity at low water: 650 t at T = 1.2 m, and 2500 t at T = 2.05 m;
- diesel-electric propulsion system with stage V engines for very low emissions; the gensets can be replaced by other generator types, e.g. hydrogen fuel cells, once they are ready for the market;
- three electric drivetrains with three propellers optimised for shallow water operation and normal water conditions; the outer propellers have a smaller diameter than the centre propeller which ensures additional thrust at normal water conditions;
- three rudder blades behind the outer propellers for sufficient rudder force, compensating for the lack of rudder surface of an ordinary rudder arrangement at the smaller propeller diameters, one rudder blade at the centre propeller for sufficient course keeping<sup>20</sup>;
- Van der Velden® FLEX Tunnel left and right of the outer drive trains (Fig. 46); these flexible tunnels are integrated into the hull and can be deployed and retracted at any time; when deployed, they optimise the water flow to the propellers; if the water depth is sufficient, the tunnels are superfluous and they will be retracted;
- hydrodynamic optimisation using model tests at the DST;
- lightweight construction ensuring high structural stability by transferring methods from seagoing shipbuilding to inland waterway vessels;
- ten stainless steel tanks and three separate loading systems for maximum flexibility with respect to chemical products to be transported (it can also be used for products with high density, such as acids and alkalis).

#### 4.5. HGK-tanker

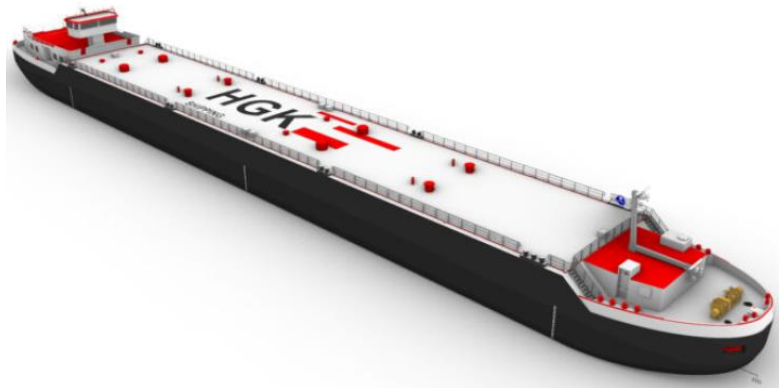

Figure 47: Animation of shallow-water gas tanker “Gas 94” of HGK Shipping. Source: HGK Shipping<sup>21</sup>.

Triggered by economic consequences of the extreme low water in 2018, on September 30<sup>th</sup>, 2021, the gas tanker “Gas 94” was officially taken into operation (Fig. 47). It is an innovative shallow-water gas tanker of HGK Shipping, designed and built on behalf of BASF. Its purpose is to secure the raw material supply (liquified gasses) of the BASF production site in Ludwigshafen. Its sailing area is located between the ARA ports and Ludwigshafen, characterised by the critical shallow water section at Kaub on the Rhine (HGK (2021 b)).

The vessel has been designed for improved performance at shallow water conditions and equal fuel consumption compared with optimised standard vessels. Worthwhile to note is that improved shallow-water performance has been achieved by proper design and engineering and not by usage of alternative materials (Schippers (2022)).

<sup>20</sup>[https://archive.damen.com/en/news/2021/05/dmc\\_flex\\_tunnels\\_three\\_nozzles\\_and\\_three\\_manoeuvring\\_systems\\_for\\_new\\_tanker\\_for\\_stolt\\_and\\_basf](https://archive.damen.com/en/news/2021/05/dmc_flex_tunnels_three_nozzles_and_three_manoeuvring_systems_for_new_tanker_for_stolt_and_basf)

<sup>21</sup>[http://www.hgk.de/images/downloads/presse/2021/Gas94\\_HGK\\_Shipping\\_Animation.jpg](http://www.hgk.de/images/downloads/presse/2021/Gas94_HGK_Shipping_Animation.jpg)

---

The vessel displays the following features (HGK (2021 a, b), Schippers (2022)):

- slightly increased breadth (instead of 11.45 m): L = 110 m, B = 12.5 m, depth = 5.6 m<sup>22</sup>;
- voluminous foreship;
- diffusor-like aft ship preventing ventilation at low water depths;
- small propeller diameters;
- reduced draught by 30 to 40 cm;
- ability to pass Kaub at a water level of 30 cm with 200 t of cargo (water depth of 1.6 m, see Section 4.4);
- Power Management System and diesel-electric propulsion: three ducted rudder propellers, each driven by a 405 kWe electric motor: 30 % less CO<sub>2</sub> emissions;
- compliance with Stage V regulations for lowest pollutant emissions;
- optimisation of design of cargo tanks for weight reduction;
- higher construction costs in comparison with standard vessels.

HGK continues the purchase of further shallow-water vessels (HGK (2022)). On February 9<sup>th</sup>, 2022, the contract for the delivery of the gas tanker “Gas 95” was signed. It is to be built in the TeamCo Shipyard in the Netherlands. The design will be similar to the one of the “Gas 94”, however, the breadth will be 11.45 m in order to allow for flexible operation on the canal system of Western Europe. The delivery of the vessel is foreseen for 2023.

In 2022, the construction of a third vessel is intended to be contracted, and four additional ones shall follow in the coming years.

---

<sup>22</sup> <https://www.teamcoshipyard.nl/en/portfolio/WVDj4FT/mgt-gas-94>



## 5. Dedicated subsidy programmes

In the Federal Republic of Germany, the national funding programme for the sustainable modernisation of inland vessels (Richtlinie zur Förderung der nachhaltigen Modernisierung von Binnenschiffen) has been pursuing the goal of reducing pollutant and greenhouse gas emissions from inland waterway vessels by promoting the installation of lower-emission engines since 2007. On July 1<sup>st</sup>, 2021, the EU Commission approved the further developed new funding directive<sup>23</sup> (Bundesministerium für Verkehr und digitale Infrastruktur (2021)), being valid till December 31<sup>st</sup>, 2023.

Through targeted incentives for investments in digitalisation and automation, conversion measures for greater operability at low water, energy efficiency measures and engines running on alternative, especially renewable fuels, hybrid drives or zero-emission drives, the conditions for the competitiveness and future viability of inland navigation as a safe and effective mode of transport in the multi-modal transport chain are to be created. At the same time, inland navigation should contribute to achieving the clean air and climate protection goals of the transport sector.

The funding programme supports amongst others dedicated measures for optimisation of cargo vessels for improved operation at low water, comprising for example:

- measures to be applied to the aft ship:
  - exchange of the aft ship by another one;
  - optimisation of the aft ship by different constructive implementations, e.g. installation of a propeller tunnel or a flex tunnel;
  - optimisation of propulsion devices by modifications of propellers, installation of ducted propellers, rudder propellers, pump-jet or other innovative solutions for propulsion;
  - optimisation of the inflow to the propeller by installation of flow-control devices;
  - optimisation of the wake by installation of a flow plate;
- measures to be applied to the foreship:
  - exchange of the foreship by another one;
  - optimisation of the foreship by constructive modifications for reduction of resistance;
  - installation of assistance solutions for improved manoeuvring, e.g. bow thrusters.

The measures are only eligible for funding if, after the execution of the modification, the vessel dedicated to the transportation of cargo features a safe manoeuvrability at a minimum draught reduced by at least 15 cm compared with the original condition. The modifications must not have a negative impact on the energy demand at normal loading conditions.

In the case of exchanging the aft ship and the foreship, the transitional regulations in accordance with the latest version of the ES-TRIN and the instruction ESI-IV-1 are to be taken into account.

The evidence of improvement is to be provided by suitable means, e.g. a comparative calculation for representative sailing routes, including representative operational profiles, where the inland waterway vessel dedicated to the transport of cargo shall be operated, or results of model tests and CFD simulations.

Acknowledging the importance of coping with low-water events, also in Austria a subsidy programme containing similar items as the one of Germany was initiated by the Federal Ministry for Climate, being currently under evaluation.

<sup>23</sup> [https://www.elwis.de/DE/Service/Foerderprogramme/Nachhaltige-Modernisierung-von-Binnenschiffen/Foerderrichtlinie.pdf?\\_blob=publicationFile&v=8](https://www.elwis.de/DE/Service/Foerderprogramme/Nachhaltige-Modernisierung-von-Binnenschiffen/Foerderrichtlinie.pdf?_blob=publicationFile&v=8)

---

## 6. Recommendations for research and development

In general, it is necessary to re-evaluate the logistical concepts in place today, including the size and design of vessels. According to ZKR (2021), the consideration of smaller vessels being able to be operated together with a lighter will gain more significance. In addition, research and development activities targeting existing vessels, as well as new buildings will be required. Such new concepts will contribute to the reduction of the vulnerability of inland waterway transport to low-water events, but they will not solve the problem what for additional measures with respect to climate resilient infrastructure, provision of reliable information with respect to navigation conditions, as well as logistics and vessel operation are required. While measures for adaptation of existing vessels are limited mainly to local modifications and replacement of the aft ship, aiming largely at increasing the cargo capacity at low water, new buildings show a greater potential for implementation of a number of measures, e.g. lightweight solutions, multiple propulsion devices, hull-form optimisation, variation of main parameters, etc., resulting in improved shallow-water performance and competitive performance at normal water levels.

More research is needed with respect to the provision of reliable data on and forecasting of environmental framework conditions as a precondition for the proper retrofitting and design of inland waterway vessels. The adaptation measures shall not negatively affect the operation of vessels at normal navigation conditions, e.g. increasing the energy demand.

Better understanding of the real sailing profiles allows the vessels to be designed more in line with the real conditions, which is also required for the energy transition. The ship design has to be optimised for the real operating conditions, taking into account rising OPEX with sustainable energy carriers, new ship main dimensions, structures, drivetrains, hull forms and the associated hydrodynamics. Showing still a lot of room for improvement, manoeuvring models for automatic navigation shall be developed, leading possibly to a business case for smaller units, e.g. due to lower personnel costs as a part of the ship operation may be carried out automatically with less personnel. In general, measures relating to the improvement of the competitiveness of smaller, less vulnerable vessels in comparison to bigger ones shall be elaborated, including the creation of regulations for proper implementation. Investigations of extreme shallow water conditions request further research with respect to interaction with river beds and squat effects in combination with small under-keel clearance.

Reliable and efficient prediction of ship operation with ventilating propellers is to be further investigated. In general, model tests and numerical methods can be used for this purpose. Challenges of model tests relate to the assessment of scaling effects, correct propeller loading and application of proper friction deduction force. Numerical simulations are associated with high computational costs for large-Reynolds-number simulations and propeller modelling. Further challenges relate to turbulence modelling and free-surface capturing. The objectives to be achieved are save accelerations, save stopping and save manoeuvres.

Finally, the impact of the introduction of new low-emission or zero-emission solutions for coping with the climate objectives of the EU, increasing eventually the weight and size of vessels, e.g. by full-electric sailing or usage of hydrogen and fuel cells, has to be considered with respect to proper operation during low-water events.

With respect to the adaptation of the fleet, a dialogue between industry, logistics, politics, and environmental organisations, as well as regulations and funding for modernisation on European level will be necessary. Proper cooperation between the different stakeholders and an integrated approach for coping with climate change is necessary, what for also the European institutions are needed.

## Annex 1: References

- Ademmer, M., Janssen, N., Kooths, S. and Möhle, S. (2019). Niedrigwasser bremst Produktion (Low water slows production level), in: Wirtschaftsdienst 99 (1), 79-80.
- Bačkalov, I., Kalajdžić, M., Momčilović, N. and Rudaković, S. (2016). A study of an unconventional container vessel concept for the Danube. *PRADS 2016 conference, Copenhagen 2016*.
- BASF (2021). BASF presents innovative tanker for low water on the Rhine. News release, January 21, 2021.
- Blank, B. (2022). Adaptation of logistic chains for low-water situations from an industry perspective. BASF, presentation, Platina 3 Stage Event 3 (Brussels Sessions), February 10, 2022.
- Bertram, V. (2012). Practical ship hydrodynamics. Second edition. Published by Elsevier Ltd.
- BfG – Bundesanstalt für Gewässerkunde (2019). Das Niedrigwasser 2018. DOI: 10.5675/BfG Niedrigwasserbroschuere\_2018.
- Bilen, B. and Žerjal, M. (1999). An optimized propulsive and manoeuvring system for river pushboats. *RINA International Conference on Coastal Ships and Inland Waterways*, London, 1999.
- Binnenschifffahrt (2021). Flachgängigkeit als Gebot der Stunde. Article written by Prof. em. Horst Linde, February 12<sup>th</sup>, 2021.
- Breslin, J. P. and Anderson, P. (1994). Hydrodynamics of ship propellers. Cambridge University Press.
- Bundesministerium für Verkehr und digitale Infrastruktur (2021). Richtlinie zur Förderung der nachhaltigen Modernisierung von Binnenschiffen vom 24. Juni 2021.
- CCNR (2019 a). Annual report 2019 – inland navigation Europe - market observation.
- CCNR (2019 b). Market insight – inland navigation in Europe. Published in November 2019.
- Guesnet, T., Zöllner, J. and Ley, J. (2021). Das Binnenschiff: Neue Anforderungen durch Niedrigwasser. Klima und Wasserstraßen, SPC 22.04.2021.
- ECCONET (2012). Deliverable 2.1.1 IWT fleet and operation. Technical report of the FP7 EU project ECCONET.
- ES-TRIN (2021). European Standard laying down Technical Requirements for Inland Navigation vessels. CESNI.
- European Commission (2019). Handbook on the external costs of transport. Version 2019.
- European Commission (2021). NAIADES III - Boosting future-proof European inland waterway transport. COM(2021) 324 final.

Friedhoff, B. et al. (2020). Detailed requirements for innovative vessel and cargo handling concepts - D4.1. Technical report of the H2020 EU project Novimove.

GL (2011). GL Rules for classification and construction of inland navigation vessels. Germanischer Lloyd.

Godjevac, M., Schweighofer, J. and Vredeveltdt, L. (2014). Probabilistic evaluation. Technical report of the FP7 EU project MoVe IT!.

Guesnet, T., Zöllner, J. and Ley, J. (2021). Das Binnenschiff: Neue Anforderungen durch Niedrigwasser. Presentation given at the online conference „Klima & Wasserstraße“ on 22.04.2021, DST - Entwicklungszentrum für Schiffstechnik und Transportsysteme e. V., Duisburg.

HGK (2021 a). Press release, January 21<sup>st</sup>, 2021.

HGK (2021 b). Press release, October 1<sup>st</sup>, 2021.

HGK (2022). Press release, February 10<sup>th</sup>, 2022.

Holtmann, B. and Bialonski, W. (2009). Einfluss von Extremwasserständen auf die Kostenstruktur und Wettbewerbsfähigkeit der Binnenschifffahrt. *Proceedings of Kliwas - Auswirkungen des Klimawandels auf Wasserstraßen und Schifffahrt in Deutschland, 1. Statuskonferenz am 18. und 19. März 2009*, BMVBS, Bonn.

IDV (2014). Innovative Danube Vessel - Main project results. Danube region strategy.

INBAT (2005). Final technical report – including technological implementation plan. Technical report of the INBAT project funded by the European Community under the ‘Competitive and Sustainable Growth’ Programme (1998-2002).

Jägers, G. (2005). Niedrigwasser in der Tankschifffahrt. Reederei Jägers, presentation given at *Rhine-River-Conference in Koblenz, 26. April, 2005*.

Klein, B. and Meißner, D. (2017). Vulnerability of inland waterway utransport and waterway management on hydro-meteorological extremes. Deliverable 9.1 of the H2020 EU project IMPREX.

Kramer, N., Mens, M. D., Beersma, J. K., and Kielen, N. R. (2019). Hoe extreem was de droogte van 2018? H20-online, 1–7.

Liu, J, Hekkenberg, R., Rotteveel, E. and Hopman, H. (2015). Literature review on evaluation and prediction methods of inland vessel manoeuvrability. *Ocean Engineering 106*. doi.org/10.1016/j.oceaneng.

Molland, A., Turnock, S. and Hudson, D. (2017). Ship resistance and propulsion - practical estimation of ship propulsive power. Cambridge University Press.

Negrea, G. (2016). Difficulties in cargo shipment on the Danube, 2015 – 2016. National User For a – Synergies FAIRway Danube – FAST DANUBE, Galati, Romania, 21. September, 2016.

NOVIMAR (2020). Deliverable 4.4 Vessel design. Technical report of the Horizon 2020 EU project NOVIMAR.

PIANC (1992). Capability of ship manoeuvring simulation models for approach channels and fairways in harbours. Report of Working Group Nr. 20 of the Permanent Technical Committee II.

Peeters, G., Afzal, MR., Vanierschot, M., Boonen, R. and Slaets, P. (2020). Model structures and identification for fully embedded thrusters: 360-degrees steerable steering grid and four channel thrusters. *J. Mar. Sci. Eng. 8*, doi:10.3390/jmse8030220

Pompèe, P.-J. (2015). About modelling inland vessels resistance and propulsion and interaction vessel – waterway. Key parameters driving restricted/shallow water effects. *Proceedings of Smart Rivers 2015*, Buenos Aires, Argentina, 7.-11. September, 2015.

PROMINENT (2015). D1.1 List of operational profiles and fleet families. Technical report of the H2020 EU project PROMINENT.

Radojčić, D. (2009). Environmentally friendly inland waterway ship design for the Danube river, World Wide Fund for Nature International Danube-Carpathian Programme (WWF-DCP).

Radojčić, D., Simić, A., Momčilović, N., Motok, M. and Friedhoff, B. (2021). Design of contemporary inland waterway vessels - the case of the Danube river. First edition, Springer.

Ramne, B. et al. (2020). D4.2 - Concepts and selection of innovative NOVIMOVE concepts. Technical report of the H2020 EU project Novimove.

Reynolds, J. (1976). Ship turning characteristics in different water depths. *Safety at Sea International, Issue 90, 1976*.

Rotteveel, E. (2013). Investigation of inland ship resistance, propulsion and manoeuvring using literature study and potential flow calculations. Master thesis. Delft University of Technology.

Schippers, M. (2022). WG: Gas 94, Gas 95: Höfliche Bitte bezüglich Informationen zu Niedrigwassertanker. Personal conversation. E-Mail: March 25<sup>th</sup>, 2022.

Schiffahrts-Museum Regensburg e.V. (2004). Donau-Schiffahrt-175 Jahre Erste Donau-Dampfschiffahrtsgesellschaft. Sonderband der Schriftenreihe des Arbeitskreises Schiffahrts-Museum Regensburg e. V.

Schneekluth, H. (1988). Hydromechanik zum Schiffsentwurf. Third edition, Koehler.

Scholten, A. and Rothstein, B. (2012). Auswirkungen von Niedrigwasser und Klimawandel auf die verladende Wirtschaft, Binnenschiffahrt und Häfen entlang des Rheins – Untersuchungen zur gegenwärtigen und zukünftigen Vulnerabilität durch Niedrigwasser. Heft 107, Mitteilungen der Geographischen Gesellschaft Würzburg.

SPS Technology (2020). What is SPS? [www.spstechnology.com/what-is-sps](http://www.spstechnology.com/what-is-sps). Accessed January 29<sup>th</sup>, 2021.

Schweighofer, J. (2013). The impact of extreme weather and climate change on inland waterway transport. *Journal Natural Hazards*, DOI 10.1007/s11069-012-0541-6, Springer Verlag.

Schweighofer, J. and Suvačarov, A. (2018). Evaluation of the fuel-consumption-reduction potential of a Danube vessel. *Proceedings of 7<sup>th</sup> Transport Research Arena TRA 2018*, April 16-19, 2018, Vienna, Austria.

Schweighofer, J. et al. (2018). D5.13 Technical evaluation report on pilot test case energy-efficient navigation. Technical report of the H2020 EU project PROMINENT.

Stefanović, A. (2019). Structural analysis of an unconventional inland container vessel using finite element method. MSc Thesis, University of Belgrade, Faculty of Mechanical Engineering

Streng, M., van Saase, N. and Kuipers, B. (2020). Economische impact laagwater. Een analyse van de effecten van laagwater op de binnenvaartsector en de Nederlandse en Duitse economie, final report of the Erasmus Centre for Urban, Port and Transport Economics.

Van der Mark, r. (2021). Toekomstverwachtingen laagwater en gevolgen voor bevaarbaarheid - SAMEN AAN DE SLAG VOOR VEERKRACHTIG EN DUURZAAM TRANSPORT. Deltares, Presentation given at Laagwater Event 2021 an initiative of Schuttevaer & Nieuwsblad Transport.

Vantorre, M., Eloot, K., Delefortrie, G., Lataire, E., Candries, M. and Verwilligen, J. (2017). Maneuvering in shallow and confined water. *Encyclopedia of Maritime and Offshore Engineering*, online © 2017 John Wiley & Sons, Ltd., DOI: 10.1002/9781118476406.emoe006

VBD - Versuchsanstalt für Binnenschiffbau e.V., Duisburg (2004). Technische und wirtschaftliche Konzepte für flußangepaßte Binnenschiffe. Bericht 1701 (Schlußbericht), Forschungsbericht FE-Nummer: 30.0328/2003.

VBW-Verein für europäische Binnenschifffahrt und Wasserstraßen e.V. (2021). Stärkung der Robustheit der Wasserstraßen in außergewöhnlichen Niedrigwassersituationen. Abschlussbericht.

viadonau (2019). Manual on Danube Navigation. Handbook published by via donau – Österreichische Wasserstraßen-Gesellschaft mbH.

Weitzenböck, J. (2012). Adhesives in marine engineering. Woodhead Publishing, ISBN 9780857096159.

Wessel, H. and Menzel, T. (2006) Extreme hydrologische Ereignisse im Donauegebiet (Niedrig- und Hochwasser, Eisverhältnisse, ...) und ihre Bedeutung für den Betrieb der Bundeswasserstraßen. Bundesanstalt für Gewässerkunde—Veranstaltungen - Gewässerkundliche Untersuchungen für verkehrliche und wasserwirtschaftliche Planungen an Bundeswasserstraßen, Kolloquium am 17. Januar 2006 in Koblenz.

Zigic, B., Holtmann, B., van Heumen, E., Ubbels, B. and Quispel, M. (2012). Deliverable 2.1.1 – IWT fleet and operation, technical report of the FP7 EU-project ECCONET.

ZKR – Zentralkommission für die Rheinschifffahrt (2021). Reflexionspapier „Act now!“ zum Thema Niedrigwasser und Auswirkungen auf die Rheinschifffahrt, Edition 2.0.

## Annex 2: Platina 3 Stage Event 3 (Brussels Sessions) – agenda and minutes of climate change sessions (draft 25.3.2022)<sup>24</sup>

### Day 1 - 10<sup>th</sup> of February 2022<sup>1</sup>

09:00 – 09:10	Opening
09:00 – 09:10	<b>Welcome and introduction by Event Host Karin De Schepper and Project coordinator Martin Quispel</b>
09:10 – 10:45	Climate resilient vessels (moderator: Willem Jan Goossen, EC DG CLIMA)
09:10 - 09:25	<b>Climate change in the Danube River basin: future scenarios</b> - Wolfram Mauser, Ludwig-Maximilians-University Munich
09:25 - 09:40	<b>Risk of climate change on German waterways: what do we expect?</b> - Enno Nilson and Bastian Klein, Bundesanstalt für Gewässerkunde
09:40 – 09:55	<b>Impacts of low water on inland waterway transport and the economy</b> - Kai Kempmann and Laure Roux, Central Commission for the Navigation of the Rhine
09:55 – 10:15	<b>Recent technology developments and future research needs relating to vessels to be operated under extreme low-water conditions</b> - Benjamin Friedhoff, DST Entwicklungszentrum für Schiffstechnik und Transportsysteme
10:15 – 10:30	<b>Innovative tanker design for coping with low-water events on the Rhine: the BASF case</b> - Benoit Blank, BASF
10:30 – 10:45	<b>Questions and answers – interactive discussion</b>
10:45 – 11:00	Coffee break

<sup>1</sup> All times in Central European Time (CET), version 20220209

### Session 1. Climate resilient vessels (moderator: Willem Jan Goossen, EC DG CLIMA)

The first session was opened by the moderator **Mr. Willem Jan Goossen**, policy officer from EC DG CLIMA, expert in climate adaptation and specialised in water, stating that the climate is changing and the waters will be severely affected. After a brief overview of the session he gave the floor to the first speaker.

**Prof. Wolfram Mauser** from the Ludwig-Maximilians-University (LMU) in Munich, Germany started his presentation on “Climate Change and the Danube River Basin – Assessment and Next Steps” by referencing the IPCC Assessment Report mentioned earlier by the moderator of the session, Mr. Goossen from the European Commission (DG CLIMA). Prof. Mauser mentioned that the report showed a lot of consolidation and no breaking news for the Danube and many parts of the world. He said: “The main take home message is that every additional ton of future greenhouse gas emission will almost linearly add to a change in climate drivers.” He stated that the IPCC stands behind the Paris Accord of a limit of 1.5 °C on global warming but also considers seriously a larger degree of warming of 2 to even beyond 4 °C. The global mitigation goals are getting sharper and clearer defined, but adaptation to regional impacts has not yet been assessed. He then showed a graph that illustrated once again how each additional ton of greenhouse gas emissions results in a linear increase in global temperature. He continued by mentioning that the global climate behaves differently on a regional level. For example, a 4 °C increase in global temperature would mean an 8 °C or even higher increase of the temperature in the northern hemisphere. For the Danube Basin,

<sup>24</sup> <https://platina3.eu/download/minutes-of-the-3rd-stage-event-the-brussels-sessions/>, accessed 23.5.2022.

a global warming of only 2 °C would relate to 3-4 °C increase in temperature. Regarding rainfall patterns: Precipitation changes are much more complex than the temperature. Rainfall amounts will change in the future and appear to be changing more intensely due to increased global warming. The Danube region is in the fringe between an increase and a reduction of precipitation. He said that one of the reasons why it is so difficult to make predictions is that there is no consistent picture of temperature increase values from National Adaptation Studies but that from the data available it shows that regional temperature increase average in the Danube River Basin is largely consistent with global patterns and about twice the global average. The studies done in the 2010s on precipitation patterns show no clear picture. Precipitation patterns are complex and uncertain. They show increase in winter and decrease in summer. However, the central and lower Danube lacks seasonal far future perspective. Nevertheless, there seems to be agreement that summer precipitation will decrease in these regions. Across the Danube region, the scientific community seems to agree with a high degree of certainty that temperatures will rise but there is much disagreement on for example floods, weather patterns or the economy. Regarding runoff, there is also a high level of uncertainty. There is also very little agreement on the impacts of climate change on inland navigation on the Danube. Prof. Mauser further stated that Climate Change will affect not only ecosystems and water, but also the supra-national energy market as well as the global food market. He showed a graph of a model that examines the impact of irrigating all the maize fields we already have today. The results showed almost no runoff changes in the upper Danube region but they showed an almost 60 % runoff reduction in the summer at the Danube's mouth. Prof. Mauser concluded that "Climate Change is a driver but there are indirect drivers that are maybe much more dominant in affecting the runoff in the river basin." Prof. Mauser finished his presentation by summarising the main takeaways. He again said that national approaches to study designs are the wrong way and that a basinwide integrated analysis of coupled impacts is needed.

**Dr. Bastian Klein** from the Federal Institute of Hydrology (BfG) in Germany started his presentation with the title "Risk of Climate Change on German Waterways" with graphics of five different climate impact chains regarding navigation. He stated that he would mainly concentrate on three of them which ultimately concern water level above threshold, icing and low flow events. He further explained that the job of the BfG is to "translate" the research (for example the research Prof. Mauser presented before) for the waterway user. He then went on to show a low flow graphic which displayed the impact of climate change on low flow on the Rivers Rhine, Main and Danube. The graph summarising climate projections from 2031 to 2060 showed large uncertainties when it comes to future Q20 (discharge being exceeded 20 days during a year on average, roughly equivalent to GIQ on the Rhine and LNQ on the Danube) undershoot. In contrast, the summarized projections from 2071 to 2100 showed a much clearer picture. The days on which the Q20 value is undershot will clearly increase. Dr. Klein put all these values in relation to the numbers from the 2018 low water period. He then went on to show a graph which showed the high flow observations, projections and simulations for the Danube between the years 1971 and 2100. It showed clearly that in the future navigation on the Danube will more often be restricted due to floods. The same scenario is emerging for the rivers Rhine and Main. Dr. Klein then went on to show a graph of ice observations between 1970 and 2020 on the Main/Main-Danube canal. It showed that the days with restrictions due to ice formation approximately coincide with the days when the temperature was below 0 °C. Therefore, the temperature was used as a proxy for future ice formation days. He then showed a graph that summarised 16 projections until 2100 and it showed that in the future there will be less restrictive days due to ice but there will still at least be some ice winters in the far future. Dr. Klein then went over legal aspects of climate impacts in Germany and the legal need for different stakeholders to have decent knowledge about the future of climate change. Next, he showed the eight-point plan of the German federal ministry of Transport and Digital Infrastructure, which aims to show how inland navigation should adapt to climate change on the Rhine. Those measures are so called no-regretmeasures, because they show improvements in the resilience against extreme weather events even without climate change. Dr. Klein went on and concentrated mainly on the first three points of this eight-point plan, namely: water level prediction, climate change service and online depths information. Regarding water level predictions, the forecast scale depends on the travel distance. Shorter distances require short term forecasts, longer distances require long term forecasts. The BfG provides deterministic 4-day predictions, probabilistic 10-day and 6-week predictions, as well as probabilistic 3-month estimates. Dr. Klein concluded his presentation referring to the Climate Change Service Portal of BfG that can be accessed at <https://ws-klimaportal.bafg.de> .



**Mr. Kai Kempmann** and **Ms. Laure Roux** from the CCNR gave an overview of the impacts of low water on inland waterway transport and the economy relying on this transportation mode. The elaborations were focussed on the year 2018, which was characterised by very severe and long-lasting low-water occurrence on the Rhine, Danube, Weser and the Elbe. However, the year 2018 was not the severest low-water event in the last century, displaying 11 extreme low-water periods on the Rhine, which occurred also more frequently. The last very severe event took place 1971. Having a look into the past, a favourable trend has been observed with respect to the occurrence of natural low water during a year. Considering climate change effects, the trend can become un-favourable and medium and longterm adaptation measures will become necessary. In general, the impact on inland waterway transport is affected by the following drivers: precipitation (availability of water), hydrology (discharge) and morphology (river bed, training works). Low water leads to reduced channel depth and width, limiting the cargo carrying capacity of vessels and reducing their safe operation. Although the low water event of 2018 ranges only on the 6th place of the ones since 1900, the impact on inland waterway transport was severest. Reasons for this are the development of the fleet with ever-growing size of vessels and the developments in logistics demanding just-in-time deliveries, increasing thereby the vulnerability of the logistics chain involving inland waterway transport to low-water events and climate change. In 2018, a lower volume of cargo per vessel was transported, resulting in more vessels to be employed and vessel movements. The transportation costs per ton increased by up to a factor of seven (seven times higher), the risk of accidents increased, a modal shift to other modes of transport took place (container) and the reliability of inland waterway transport was put into question. The economic losses for the manufacturing industry were dramatic amounting to approximately 5 Billion Euro only for Germany. In addition, follow-up effects with respect to stock keeping and delays in handling of cargo were observed. In consequence, the CCNR recognised the need to act “now”. In 2019, a workshop on low water and effects on Rhine navigation was organised together with the ICPR and the CHR, and a reflection paper was published in 2020 (first version) and 2021 (second version) with the title: “Act Now”. It contains amongst others a list of ongoing measures/projects relevant to the topic. With respect to the adaptation of the fleet, the following measures were highlighted: research in optimisation of existing vessels and new-builds (short-term), dialogue between industry, logistics, politics, and environmental organisations, as well as the use of smaller vessels in coupled formations (medium term).

**Mr. Benjamin Friedhoff**, Head of Hydrodynamics at DST, elaborated on recent technology developments and future research needs relating to vessels to be operated under extreme low-water conditions. The current trends in inland ship design relate to size limitations, CAPEX-oriented optimisation of hulls, economies of scale and comparison of power demand mainly at trial conditions. The size of a vessel is limited by waterway and lock dimensions, regulations and CEMT classification of waterways. Vessels are designed for maximum capacity, resulting in full hull forms and straight metal sheet constructions with increased energy demand. The vessels have become bigger: a large Rhine ship designed for CEMT Va is not regarded as large anymore. The evaluation of the power performance of a vessel is carried out at high water depths for loaded vessels with large propeller diameters, which does not reflect the real operating conditions an inland waterway vessel faces. In general, a great variety of different vessel designs exist, used for different transportation tasks, which has to be taken into account in the evaluation of the performance of a vessel. Investigations performed at DST indicate that at low water, e.g. water depth equal to 3.5 m, the design of the aft-ship has a significant influence on the delivered power, which may increase by 100 % at higher vessel speeds. The year 2018 was mentioned as one year with exceptional low-water conditions. Such events have significantly negative effect on ship performance. The operation of a propulsor will be prevented from proper operation due to ventilation, reducing the thrust to be created. In the worst case, a vessel cannot be even accelerated in order to achieve its operational speed. Ventilation can become also a problem when a vessel has to stop, as in such a case the propeller becomes highly loaded and air suction occurs easily preventing the vessel from stopping within a sufficiently short period of time or distance. In general, higher efficiency of the propulsion system is obtained by larger propeller diameters. However, larger propeller diameters are also more sensitive to ventilation which can be prevented by different measures, e.g. a propeller tunnel, a flex tunnel with good resistance characteristics at higher water levels etc. From a technical point of view, newbuilds are relatively easy to be adapted to low-water conditions. Possible solutions comprise the construction of small vessels, the design of wide vessels with reduced draught and optimised propulsion systems and design of the aft-ship, e.g. by usage of more propulsors (two or even three), application of a flex tunnel, as well as weight considerations, e.g. application of tailored hull girders, favourable distribution of weight and reduced bending at low-water conditions. Retrofitting is more complex due to the presence of the existing design. Usually, retrofitting is limited to local modifications and

replacement of the aft hull. Additional measures mentioned relate to the provision of additional buoyancy, e.g. via a dock-ship, moving the original vessel over shallows, or the application of retractable side-boxes and pipe-based elements. The main goal is to increase the cargo carrying capacity for economic operation instead of reducing the draught. Current research of the TU Delft is focussed on the provision of inflatable systems for creation of additional buoyancy (Novimove). Finally, it is concluded that more research is needed. Reliable data on and forecasting of environmental conditions are a precondition for the retrofitting and design of inland waterway vessels. The adaptation measures shall not negatively affect the operation of vessels at normal navigation conditions, e.g. increasing the energy demand. Better understanding of the real sailing profiles allows the vessels to be designed more in line with the real conditions, which is also required for the energy transition. The ship design optimised for real operating conditions has to take into account rising OPEX, new ship structures, drivetrains and hydrodynamics. Manoeuvring models for automatic navigation shall be developed, leading to a business case for smaller units. Investigations of extreme shallow water conditions request further research with respect to interaction with river beds and squat effects in combination with small under keel clearance. Reliable and efficient prediction of ship operation with ventilating propellers is to be further investigated. In general, model tests and numerical methods can be used for this purpose. Challenges of model tests relate to the assessment of scaling effects, correct propeller loading and application of proper friction deduction force. Numerical simulations are associated with high computational costs for large-Reynolds-number simulations and propeller modelling. Further challenges relate to turbulence modelling and free-surface capturing. The objectives to be achieved are save accelerations, save stopping and save manoeuvres.

**Dr. Benoit Blank**, Head of Bulk Operations Europe at BASF SE Ludwigshafen, elaborated on the adaptation of logistic chains for low-water situations from an industry perspective. The Rhine and barge operations are of critical importance for the raw material supply of the Verbundsite Ludwigshafen. The raw material supply is realised by truck (10 %), rail (25 %), barge (52 %) and pipeline (13 %). The distribution of cargo from Ludwigshafen takes place by truck (47 %), rail and intermodal transport (24 %) and barge (29 %, bulk and containers). The critical gauge for BASF on the Rhine is Kaub in the Rhine valley. Almost 80 % of the transport volumes from and to Ludwigshafen have to pass the bottleneck in Kaub. The year 2018 was characterised by very low, long lasting water levels at Kaub during the second half of the year, having had a significant impact on BASF and the inland waterway transport market. The barge capacity dropped significantly by 200-300 ton per barge, a major increase in number of shipments and shortage of barge capacity as well as availability in the market occurred. As a consequence, the freight costs (incl. demurrage) increased up to values seven times higher than during normal water levels. The logistics flows were significantly disturbed and the supply to the Ludwigshafen site was strongly impacted. Hence, BASF decided to adapt its logistics chains to future low-water periods as experienced in 2018. The development of new digital tools for provision of more accurate longer-term forecasts of Rhine water levels allows for improved operational planning and initiation of measures in order to compensate the negative effects of low water. The basis of the water-level forecasting tool is the European project IMPREX and the cooperation with the Federal Office of Hydrology (BfG). For Kaub, a 10-day up to a 6-week forecast is available for internal use. Further, the implementation of a time-charter basefleet comprising the best low-water suitable barges in the market has proven a very effective measure to secure transport capacity in the case of low water. All chartered vessels allow a passage with sufficient payload at the water level of the gauge Kaub < 60 cm. BASF, together with external partners, has developed its own type of a low-water vessel that has a high deadweight capacity of 650 tons of cargo at a draft of 1.20 m. Specific characteristics of this vessel are: optimized environmental footprint with diesel-electric engines and Stage-V exhaust gas treatment, Innovative drive with three propellers and flex tunnels optimised for extreme low-water situations as well as normal water conditions, increased payload through lightweight construction (ca. 650 t at 1.20m draught, ca. 2500 t at 2.05 m draught), improved hydrodynamics of the hull for an 135 m x 17.5 m vessel to ensure optimal flow characteristics and highest product flexibility with 10 stainless steel tanks and 3 separate loading systems. Stolt Nielsen has partnered with BASF to build and operate this low-water vessel. The commissioning of the vessel is planned for the end of 2022. Finally, the roadmap "Niedrigwasser Rhein" was mentioned as an important milestone, demanding the prioritisation of the implementation of the defined measures. With respect to the infrastructure the „Abladeoptimierung Mittelrhein“ plays a significant role. It is an ongoing infrastructure measure with a very long planning horizon (>2032). It constitutes an essential part of the BMVI's 8-point plan supported by BASF and various other parties. The integration of ecology and economy, as well as the support from political bodies and the general public is of high importance for the success of the project.

---

The session was concluded by a questions and answers round moderated by **Mr. Goossen**. Mr. Isakovic from the Sava Commission mentioned that a study on climate change impacts on the Sava river had been carried out five years ago and the results are available for interested parties. Prof. Mausers confirmed to have knowledge of this outstanding study, but stated also that it was limited to only the Sava. Mr. Leitner was interested in the existence of an interrelation between the results of BfG and the ones of Prof. Mauser. On one side, he referred to the development of discharge in the Danube region, and on the other side on the impact of withdrawal of water volumes for other purposes e.g. energy production, agriculture. Prof. Mauser stated that such a compilation had not been carried out yet. The impact of agriculture on the water regime can be very significant, even more significant than the changes due to climate change. Integrated studies considering such interactions are necessary and should be carried out. Finally, Mr. Leitner turned to Dr. Klein asking if he had observed faster changes between low water and high water in his studies. Dr. Klein confirmed that the variability is changing. It is increasing but not as much as described by Mr. Leitner. Mr. Goossen was interested in the question if there is a good cooperation between the market and authorities and how the international cooperation is with respect to this issue. Mr. Friedhoff mentioned that in the EU project Novimove a lot of international cooperation is present relating to the topic. The awareness of the stakeholders with respect to model testing and ship design for extreme conditions is not existing yet, due to the fact that these events are very rare. However, the situation is improving. Dr. Blank sees a lot of cooperation. However, regulations and funding for modernisation are often national. He stressed that it is important to have such schemes available on a European level. Ms. Roux referred to the low-water workshop in 2019, where as a main outcome the need for cooperation was stressed and initiated. The CCNR recognises the need for further activities and continues to follow this task by e.g. organisation of workshops. Mr. Sobotka stated that vessel projects become more specialised and longer charter contracts will be needed. In addition, the Rhine at Kaub displays a limitation with respect to the width for a few kilometres, becoming severer at low water and demanding modifications for improvement of transport capacity. **Ms. De Schepper** closed the session with a clear message on proper cooperation and an integrated approach for coping with climate change, what for also the European institutions are needed.



© 2021

This project has received funding from the European Union's Horizon 2020 research and innovation programme under grant agreement No 101006364. The opinions expressed in this document reflect only the author's view and in no way reflect the European Commission's opinions. The European Commission is not responsible for any use that may be made of the information it contains.

Project coordination	Stichting Projecten Binnenvaart
Contact	info@platina3.eu

